

EG5120

Hardware Manual

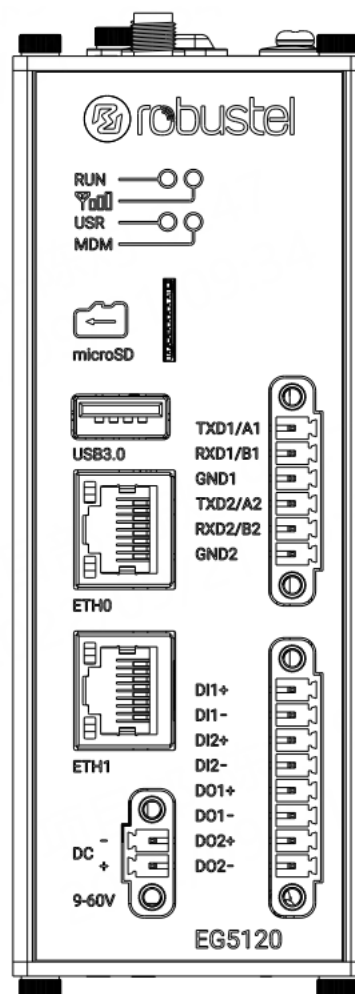

Version: 1.0.2

Date: Nov. 23, 2022

Regulatory and Type Approval Information

Table 1: Toxic or Hazardous Substances or Elements with Defined Concentration Limits

Name of the Part	Hazardous Substances									
	(Pb)	(Hg)	(Cd)	(Cr(VI))	(PBB)	(PBDE)	(DEHP)	(BBP)	(DBP)	(DIBP)
Metal parts	o	o	o	o	-	-	-	-	-	-
Circuit modules	o	o	o	o	o	o	o	o	o	o
Cables and cable assemblies	o	o	o	o	o	o	o	o	o	o
Plastic and polymeric parts	o	o	o	o	o	o	o	o	o	o

o:
Indicates that this toxic or hazardous substance contained in all of the homogeneous materials for this part is below the limit requirement in RoHS2.0.

X:
Indicates that this toxic or hazardous substance contained in at least one of the homogeneous materials for this part *might exceed* the limit requirement in RoHS2.0.

-:
Indicates that it does not contain the toxic or hazardous substance.

Radio Specifications for Europe

RF technologies	2G, 3G, 4G, 5G, GNSS, Wi-Fi*, BLE*
Cellular Frequency *	2G: GSM: B2/B3/B5/B8 3G: WCDMA: B1/B2/B4/B5/B6/B8/B19 4G: LTE FDD: B1/B2/B3/B4/B5/B7/B8/B12/B13/B18/B19/B20/B25/B26/B28/B29/B30/B32/B66/B71 LTE TDD: B34/B38/B39/B40/B41/B42/B43/B48 LAA: B46 (only supports 2 x 2 MIMO) 5G: NR SA/NSA: n1/n2/n3/n5/n7/n8/n12/n13/n14/n20/n25/n26/n28/n29/n30/n38/n40/n41/n48/n66/n71/n75/n76/n77/n78/n79
Wi-Fi Frequency	2.4 GHz: 2.412 ~ 2.484 GHz 5 GHz: 4.915 ~ 5.925 GHz
BLE Frequency	2402 ~ 2480 MHz
Max RF power	33 dBm±1dB@GSM, 23 dBm±1dB@WCDMA, 23 dBm±1dB@LTE, 23 dBm±1dB@NR, 18 dBm@WiFi, 4 dBm@BLE

* *May vary on difference models.*

Note: Operation of 5150 ~ 5250 MHz frequency range is restricted to indoor use only.

Caution: The user is cautioned that changes or modifications not expressly approved by the party responsible for compliance could void the user's authority to operate the equipment.

This device contains licence-exempt transmitter(s)/receiver(s) that comply with Innovation, Science and Economic Development Canada's licence-exempt RSS(s) and Part 15 of the FCC Rules. Operation is subject to the following two conditions:

- (1) This device may not cause interference.
- (2) This device must accept any interference, including interference that may cause undesired operation of the device.

L'émetteur/récepteur exempt de licence contenu dans le présent appareil est conforme aux CNR d'Innovation, Sciences et Développement économique Canada applicables aux appareils radio exempts de licence. L'exploitation est autorisée aux deux conditions suivantes :

- (1) L'appareil ne doit pas produire de brouillage;
- (2) L'appareil doit accepter tout brouillage radioélectrique subi, même si le brouillage est susceptible d'en compromettre le fonctionnement.

Note: This equipment has been tested and found to comply with the limits for a Class B digital device, pursuant to Part 15 of the FCC Rules. These limits are designed to provide reasonable protection against harmful interference in a residential installation. This equipment generates, uses and can radiate radio frequency energy and, if not installed and used in accordance with the instructions, may cause harmful interference to radio communications. However, there is no guarantee that interference will not occur in a particular installation.

If this equipment does cause harmful interference to radio or television reception, which can be determined by turning the equipment off and on, the user is encouraged to try to correct the interference by one or more of the following measures:

- Reorient or relocate the receiving antenna.
- Increase the separation between the equipment and receiver.
- Connect the equipment into an outlet on a circuit different from that to which the receiver is connected.
- Consult the dealer or an experienced radio/TV technician for help.

FCC& IC Radiation Exposure Statement

This equipment complies with FCC and Canada radiation exposure limits set forth for an uncontrolled environment. This equipment should be installed and operated with a minimum distance of 20cm between the radiator and your body.

This transmitter must not be co-located or operating in conjunction with any other antenna or transmitter.

Déclaration d'IC sur l'exposition aux radiations

Cet équipement est conforme aux limites d'exposition aux radiations définies par le Canada pour des environnements non contrôlés. Cet équipement doit être installé et utilisé à une distance minimum de 20 cm entre l'antenne et votre corps.

Cet émetteur ne doit pas être installé au même endroit ni utilisé avec une autre antenne ou un autre émetteur.

Simplified EU Declaration of Conformity

We, Guangzhou Robustel Co., Ltd. are located at 501, Building #2, 63 Yongan Road, Huangpu District, Guangzhou, China, declare that this radio equipment complies with all applicable EU directives. The full text of the EU DoC is available at the following internet address:

www.robustel.com/certifications/

Safety Information

General

- The router generates radio frequency (RF) power. When using the router, care must be taken on safety issues related to RF interference as well as regulations of RF equipment.
- Do not use your router in aircraft, hospitals, petrol stations or in places where using cellular products is prohibited.
- Be sure that the router will not be interfering with nearby equipment. For example: pacemakers or medical equipment. The antenna of the router should be away from computers, office equipment, home appliance, etc.
- An external antenna must be connected to the router for proper operation. Only uses approved antenna with the router. Please contact authorized distributor on finding an approved antenna.

RF Exposure

- This device meets the official requirements for exposure to radio waves. This device is designed and manufactured not to exceed the emission limits for exposure to radio frequency (RF) energy set by authorized agencies.
- The device must be used with a minimum separation of 20 cm from a person's body to ensure compliance with RF exposure guidelines. Failure to observe these instructions could result in your RF exposure exceeding the applicable limits.

Note: Some airlines may permit the use of cellular phones while the aircraft is on the ground and the door is open. Router may be used at this time.



The symbol indicates that the product should not be mixed with general household waste but must be sent to separate collection facilities for recovery and recycling.



The symbol indicates that the product meets the requirements of the applicable EU directives.



The symbol indicates that the product meets the requirements of the relevant UK legislation.

Related download link

Find more product documents or tools at:

www.robustel.com/en/documentations/

Technical Support

Tel: +86-20-82321505

Email: support@robustel.comWeb: www.robustel.com**Document History**

Updates between document versions are cumulative. Therefore, the latest document version contains all updates made to previous versions.









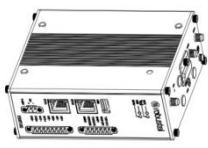

Date	Firmware Version	Document Version	Change Description
July. 6, 2022	2.0.0	1.0.0	Initial release.
Nov. 1, 2022	2.0.0	1.0.1	Added description of 4-in-1 antenna installation.
Nov. 23, 2022	2.0.0	1.0.2	Added declaration for product.

Overview

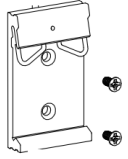
EG5120 is a new generation of industrial edge computing gateway, supporting global 5G/4G/3G/2G networks for cellular backhaul, with a fully-fledged Debian 11(bullseye) based operating system able to support thousands of existing or new ARMv8 (Raspberry Pi compatible) based applications.

Package Checklist

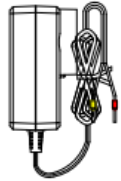
Before commencing installation ensure your package has the following components:

<p>Device</p> 	<p>2PIN Terminal Block</p> 	<p>6PIN Terminal Block</p> 	<p>8PIN Terminal Block</p> 	<p>Mounting Kit</p> 
<p>RCMS Card</p> 	<p>Quick Start Guide Card</p> 	<p>Cellular Antenna (Optional)</p> 	<p>Power Supply (Optional)</p> 	<p>Wi-Fi Antenna (Optional)</p> 

Note: The accessories could be different on specific order.

Panel Layout (May vary on different models)

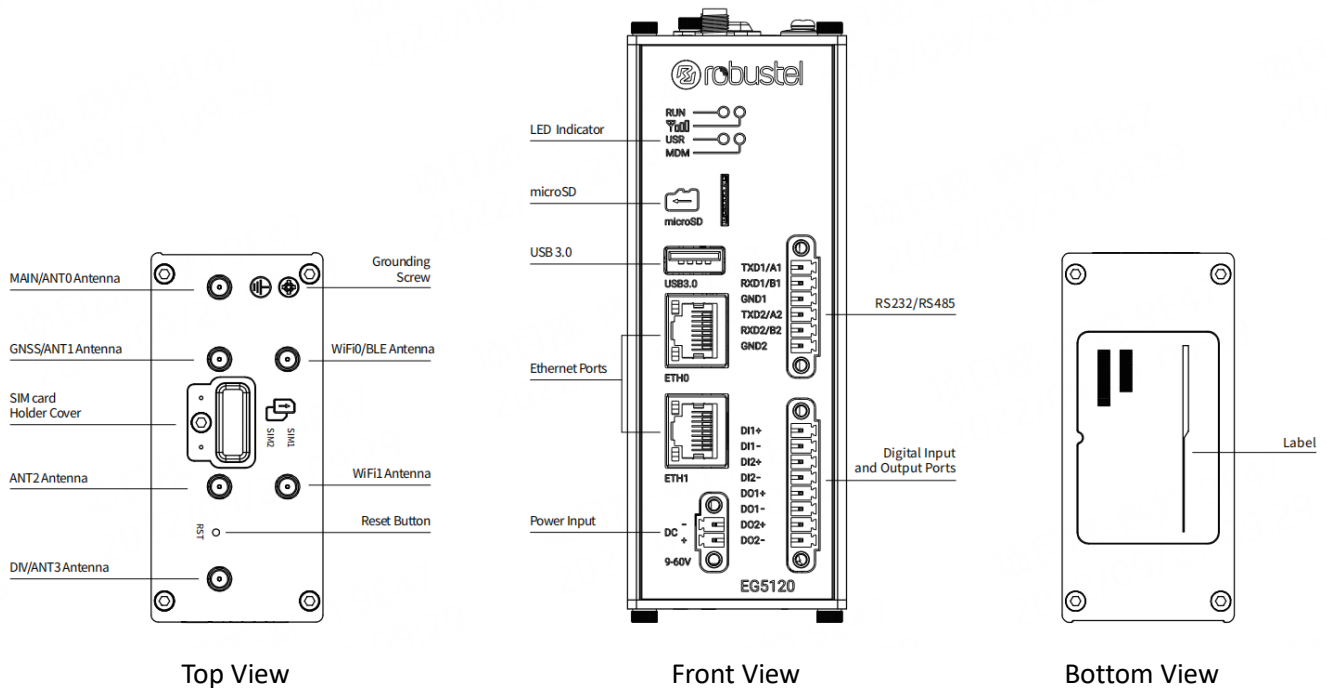

Interface Descriptions

1. **Serial Ports.** Two software configurable serial ports, could be configured as RS232 or RS485.

Name	RS232 Mode	RS485 Mode
TXD1/A1	data sending	RS485_A
RXD1/B1	data receiving	RS485_B
GND1	Ground	Ground
TXD2/A2	data sending	RS485_A
RXD2/B2	data receiving	RS485_B
GND2	Ground	Ground

2. **Ethernet Ports.** Two Ethernet ports, both of them could be configured as WAN or LAN.

LED	Description	
Activity	On, blinking	Transmitting data
	Off	No activity
Link	Off	Link off
	On	Link on

3. **Reset Button.**

Press and Release	RUN LED	Action
Hold less than 3 seconds	On then blink regularly	Reset
Hold more than 3 seconds but less than 10 seconds	Blink regularly -> blink rapidly	Restore to factory setting and reboot
Hold more than 10 seconds	Solid on for 5 seconds then blink regularly	Do nothing

4. **Digital Input and Output Ports.** Two sets of digital inputs and two sets of digital outputs. Some applications for reference are as below:

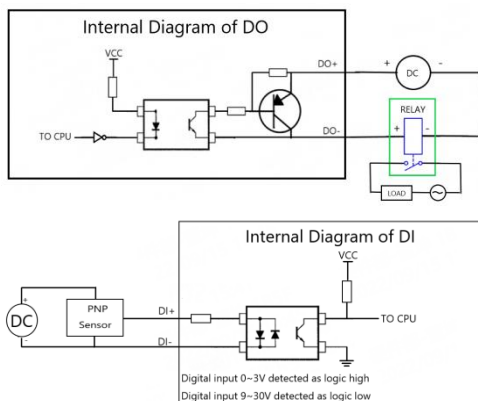

Note: The external power supply DC voltage range is 5V~30V, 0.1A max.

5. **LED Indicators.**

LED	Description	
RUN	On, solid	Gateway system is initializing
	On, blinking	Gateway starts operating
	Off	Gateway is powered off
Note: The RUN LED's color is green		
MDM	Color	With 4G Module: 2G: Red, 3G: Yellow, 4G: Green With 5G Module: 3G: Red, 4G: Yellow, 5G: Green
	On, blinking	Link connection is working
	Off	Link connection is not working
	Green	Strong signal
	Yellow	Medium signal
	Red	Weak or no signal
Note: The USR LED is defined by user via web UI to specify different status, the details see the following sheet.		

USR	Description	
None	Off	No definition
Net	On, solid	With 4G Module: Connection to the 4G network is established With 5G Module: Connection to the 5G network is established
	On, blinking	With 4G Module: Connection to the 2G or 3G network is established With 5G Module: Connection to the 4G or 3G network is established
	Off	No connection
SIM	On, solid	Main card is being used
	On, blinking	Backup card is being used
IPsec	On, solid	IPsec connection is established
	Off	IPsec connection is not established
Open VPN	On, solid	OpenVPN connection is established
	Off	OpenVPN connection is not established
Note: The USR LED's color is green.		

Hardware Installation

1. **SIM Card Installation.** Remove the SIM card cover to insert the SIM cards into the device, then screw up the cover.

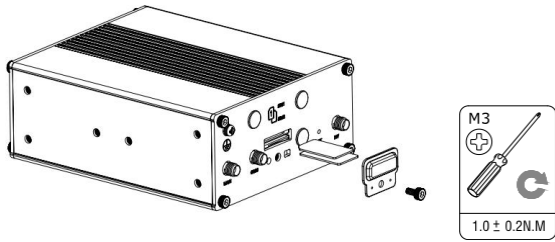

2. **Antenna Installation.** Rotate the antenna into the antenna connector accordingly. For 5G 4-IN-1 combo antenna, LHM# cable need to be connected to ANT1 and ANT2 while the MH# cable need to be connected to ANT0 and ANT3. GPS function is available when using the 4 in 1 combo antenna.

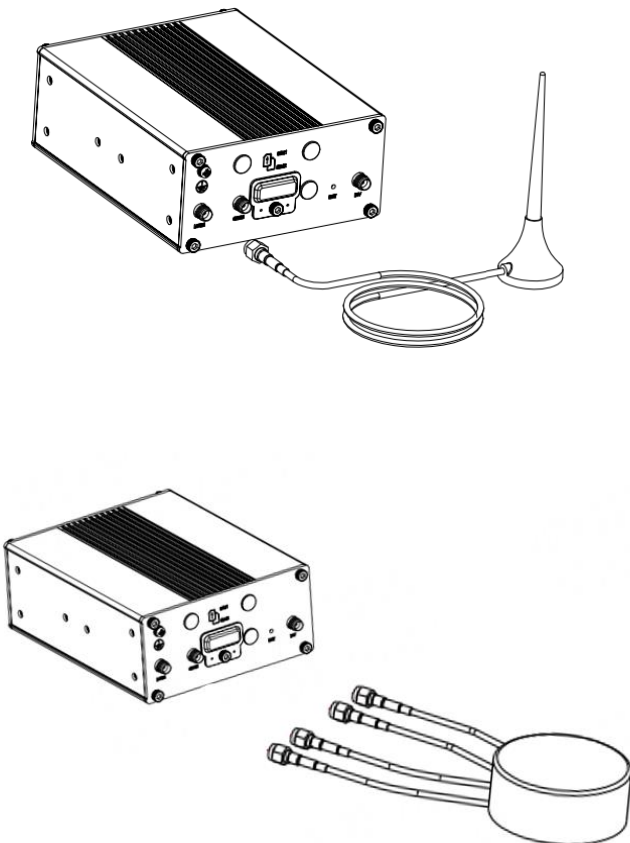

3. **Terminal Block Installation.** Insert the 6PIN and 8PIN terminal blocks into the interfaces connector, then can connect the devices or sensors to the gateway with wires via corresponding interfaces e.g. RS232/RS485, DIDO...

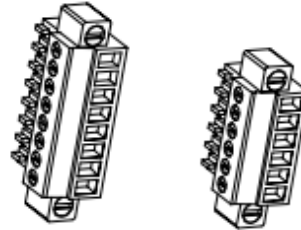

4. **Power Supply installation.** Insert the power supply cord into the corresponding terminal block if needed, then insert the terminal block into the power connector.

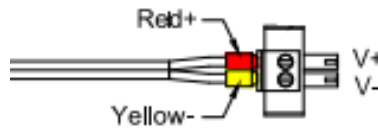

5. **DIN Rail Mounting.** Use 2 M3 screws to fix the DIN rail to the device, then hang the DIN rail on the mounting bracket.

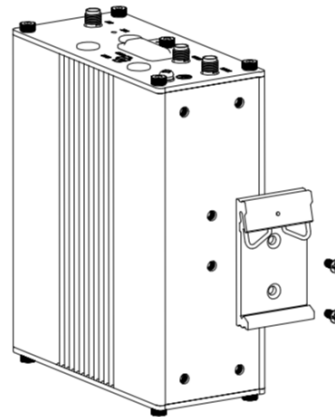

6. **Grounding the Device.** Grounding will help to prevent the noise effect due to electromagnetic interference (EMI). Connect the device to the site ground wire by the grounding screw before powering on.

Login to the Device

1. Connect the gateway’s Ethernet port to a PC with a standard Ethernet cable.
2. Before logging in, manually configure the PC with a static IP address on the same subnet as the gateway address, click and configure "Use the following IP address".

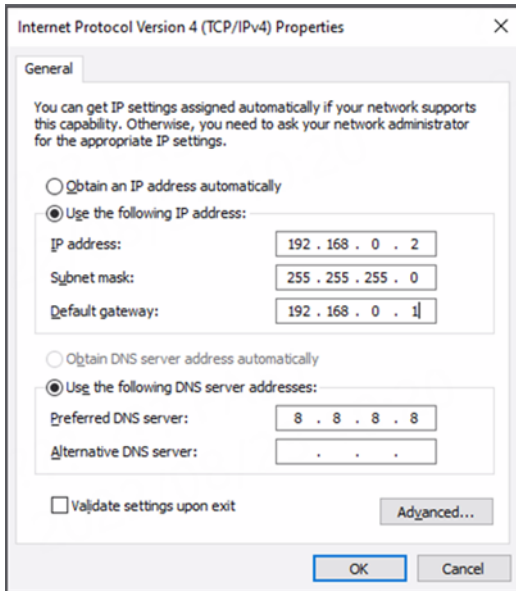

3. To enter the gateway's web interface, type <http://192.168.0.1> into the URL field of your Internet browser.
4. Use login information shown in the product label when prompted for authentication.



5. After logging in, the home page of the web interface is displayed, then you can view system information and perform configuration on the device.

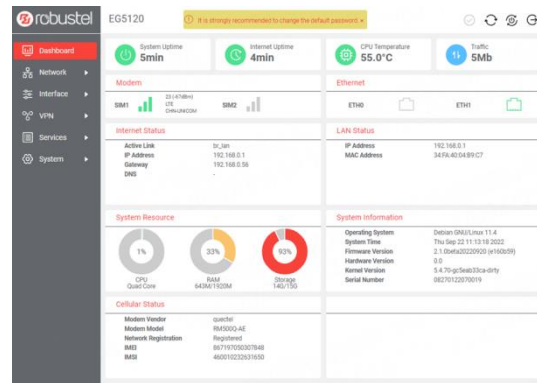

6. The automatic APN selection is ON by default, if need to specify your own APN, please go to the menu **Interface->Cellular->Advanced Cellular Setting->General Settings** to finish the specific setting.

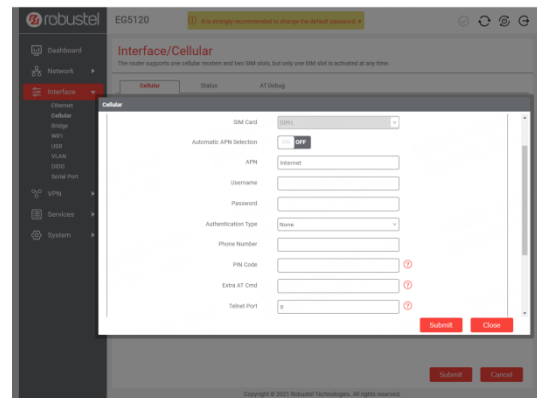

7. For more configuration details please refer to **RT104_SM_RobustOS Pro Software Manual**. (END)