

**maiwe**

MPort3101-W WiFi Serial Server

# User Manual



# Trademark

The trademark is owned by Wuhan Maiwe Communication Co., Ltd.

**MAIWE**<sup>®</sup> is the brand and registered by Wuhan Maiwe Communication Co., Ltd.

Microsoft and Windows is registered trademark owned by Microsoft.

Copyright © Wuhan Maiwe Communication Co., Ltd.

## Clarification

The user manual is applicable to MPort3101-W WiFi Serial Server.

Please read the following license agreement carefully before using this manual. The products described in this manual can be used only if you agree on the following license agreement.

## Important Statement

Any information provided by our company in this manual does not represent for corresponding authorization on these information.

Our company attempts to ensure the accuracy and applicability for the information provided in this manual, however our company does not assume any responsibility for the use of these information, and does not assume any joint responsibility for the use of these information. There may be a few technical or typographical errors in the product and manual. The company reserves the right to change all or part of this manual without prior notice.

Due to continuous update and improvement of products and technology, the contents of this document may not be completely consistent with the actual products, appreciate for your understanding. If necessary to inquiry the updates of the product, please check our official website or contact our representative directly.

Version	Date	Reason
V1.0	2019.06	Create File
V2.0	2020.06	Revise File
V3.0	2020.09	Revise File
V4.0	2021.01	Revise File
V5.0	2021.05	Revise File

# Safe Use Instructions

**This product performance is excellent and reliable in the designed range of use, but it's necessary to avoid man-made damage or destroy for the equipment.**

- Read the manual carefully and keep this manual for reference if need afterwards.
- Do not put the device close to the water sources or damp places.
- Do not put anything on the power cable, it should be placed out of reach.
- To avoid causing fire, do not knot or wrap the cable.
- Power connector and other device connectors should be firmly connected with each other, frequently inspection is needed.
- Please keep the fiber socket and plug clean. Do not look directly at the fiber section when the equipment is working.
- Please keep the equipment clean and wipe it with a soft cotton cloth if necessary.
- Please do not repair the equipment by yourself, unless there is clear instructions in the manual.

**Under the following circumstances, please cut off power immediately and contact us.**

- Equipment water damage.
- The equipment is broken or the casing is broken.
- The equipment works abnormally or the performance has completely changed.
- The equipment produces odor, smoke or noise.



**: Information requiring explanation in use of the managed software.**

Statement



**Attention : Matters requiring specific attention in the use of the managed software.**

# Chapter 1 System Overview

## 1.1 Product Introduction

Mport3101-W is a WiFi serial server product. It provides a solution for transparent transmission or protocol transmission between RS-232/485/422 interface devices and Wi-Fi networks or wired networks. It supports serial to Wi-Fi, serial to Ethernet, and Ethernet to Wi-Fi functions, and can convert serial (RS-232/485/422) into TCP/IP network interface, making The serial device connects to the TCP/IP network conveniently and quickly, and realizes the interconnection and intercommunication between the serial device and the TCP/IP network.

## 1.2 Features

### ➤ 1.2.1 Strong Functions

- Support RS-232/485/422 to WiFi/Ethernet data transmission, serial rate up to 230400bps
- Support 802.11 b/g/n standard
- Support LED status monitoring (display power, Run, Link, TX/RX)
- Support one-click restart and restore export settings
- External independent hardware watchdog design prevents crashes
- Support wireless operation AP/Client/AP+Client mode
- Support TCP/UDP/Modbus TCP protocol
- Support IP-MAC binding, static routing, PPPoE, DHCP, static IP and AUTO-IP functions
- Supports access device display, static routing, port forwarding, network diagnosis, access control blacklist
- Support NTP network automatic time adjustment
- Support WAN/LAN mode switching
- Support SNMP protocol and SNMP Trap report, email alert
- Support web login and upgrade mirror
- Support local system log, remote log, local log save regularly, etc.

### ➤ 1.2.2 Industrial-grade Interface EMC Protection

- Ethernet interface with DM  $\pm 6\text{kV}$ , CM  $\pm 2\text{kV}$  (10/700us) surge protection
- Serial connection with DM  $\pm 4\text{kV}$ , CM  $\pm 4\text{kV}$  (10/700us) surge protection
- Power connection with DM  $\pm 4\text{KV}$ , CM  $\pm 2\text{KV}$  (1.2/50us) surge protection

### ➤ 1.2.3 Industrial-grade wide-voltage power supply design

- Provide professional-grade DC power supply DC9~36V input
- With anti-reverse protection

### 1.3 Specifications

Mport3101-W	
<b>Power Supply</b>	
Voltage	DC9-36V
<b>Network port</b>	
Network port type	10/100Mbps, support MDI/MDIX cross-direct connection automatic flip
Isolation protection	1.5KV isolation protection
<b>Serial port</b>	
Number of serial ports	1 RS-232/RS-485/RS-422
Baud rate	300~230400 (bps)
Data bit	8、7、6、5
Stop bit	1、2
Check Digit	None\odd parity\even parity
<b>Others</b>	
Size	96x90x26(mm)
Working environment	-40°C~+70°C 5%~95% RH(No condensation)
Storage temperature	-40°C~+85°C 5%~95% RH(No condensation)
<b>WiFi specifications</b>	
Wireless standard	Support 802.11b/g/n
Antenna	1
Antenna interface	SMA connector (outer screw inner hole)
Wi-Fi network mode	AP/Client/AP+Client
Security Agreement	Support multiple encryption methods such as WEP, WPAPSK, WPA2PSK, etc.
<b>Wireless parameters</b>	
Frequency	Frequency Range:2412MHz--2484MHz
Transmit power	IEEE 802.11n : 15-18dBm @HT20/40 MCS7
	IEEE 802.11g : 15-18dBm @54MHz
	IEEE 802.11b : 17-19dBm @11MHz
Receiving sensitivity	Ht40 MCS7 : -69dBm@10% PER(MCS7)
	Ht20 MCS7 : -71dBm@10% PER(MCS7)
	54M: -76dBm@10% PER
	11M: -90dBm@ 8% PER

Software parameters	
Network protocol	IP, TCP, UDP, DNS, ARP, SNMP, SSH, TELNET, FTP, ICMP, HTTP, DHCP CLIENT, NTP, MODBUS TCP, UPNP
IP acquisition method	DHCP / Static IP / PPPoE / AUTO-IP
DNS	Support
User configuration	Web configuration
Simple transparent transmission	TCP Server/TCP Client/UDP Client/UDP server
Modbus	Modbus RTU/ASCII to Modbus TCP
Serial port packaging mechanism	Time and length can be set; the maximum packing length is 4kbytes
TCP Server connection	Supports up to 32 TCP connections
Network cache	Send: 16Kbyte; Receive: 64Kbyte;
Serial buffer	Send: 4Kbyte; Receive: 4Kbyte;
Flow Control	Not supported
Heartbeat package	Support TCP Keepalive mechanism, customize heartbeat packet content
Registration package	Customize the contents of the registration package
RFC2217	Support
Average transmission delay	<10ms
Supporting software	Management software
Log function	Support storage system, program operation log and log export function

## 1.4 Packing List

There are the following items in the product package. If any item is found to be missing or damaged, please contact the agent or the customer service center of Wuhan Maiwe Communication Co., Ltd., and they will assist you to replace or make up for it.

Name	Quantity	Remarks
Mport3101-W	1Unit	
Network cable	1 Piece	
Antenna	1 Piece	
RS232 cable	1 Piece	
12V power adapter	1 Piece	

# Chapter 2 Hardware and size description

## 2.1 Connection Description

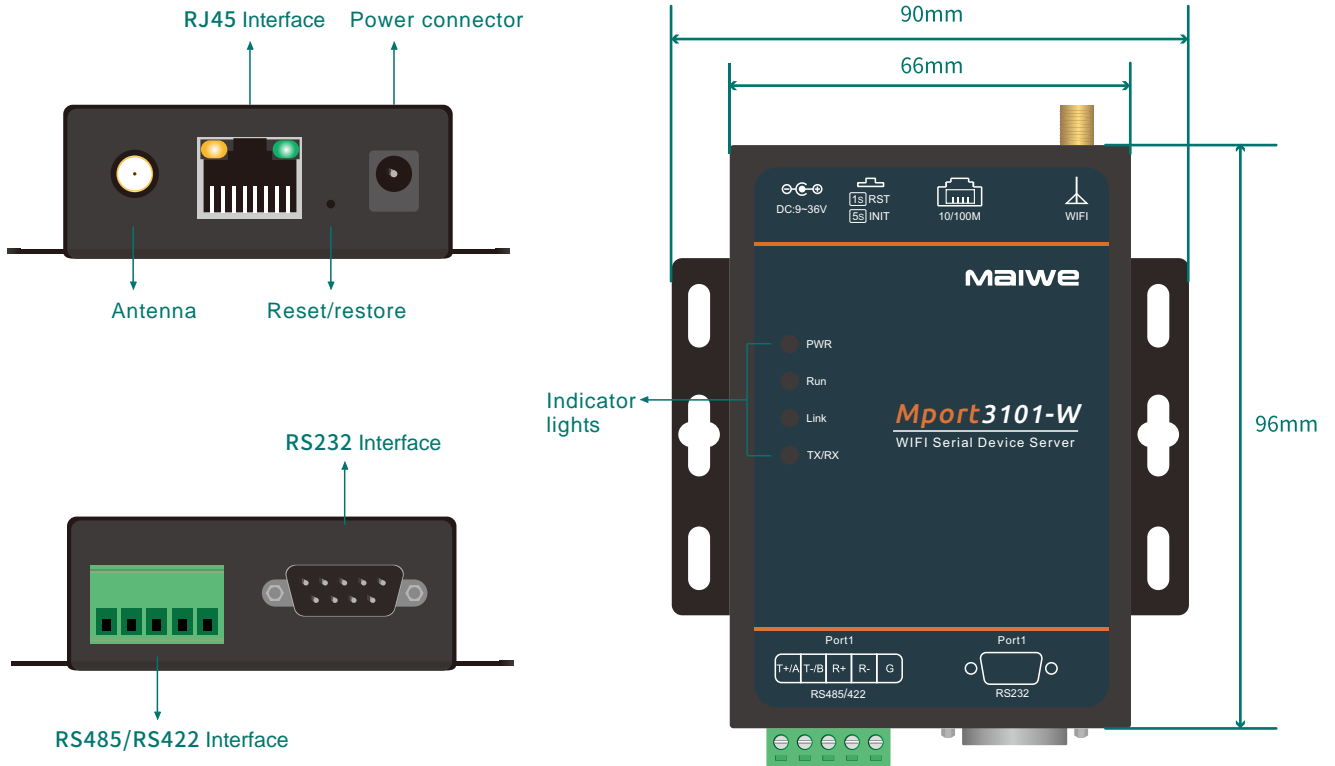

### ➤ 2.1.1 Power Input Interface

- The power interface supports DC 9-36V voltage input, and supports DC connector (2.5mm) access mode.



### ➤ 2.1.2 Serial Connection

- RS485/RS422 interface adopts 5-bit 5.08mm pitch terminal block; refer to the figure below for pin assignment of various interfaces.

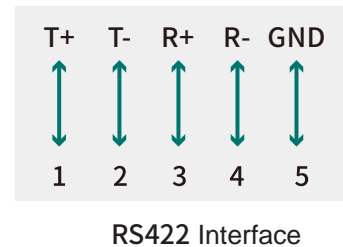
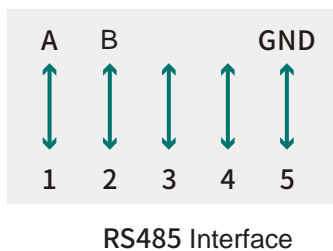
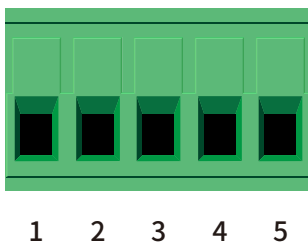

- RS232 interface adopts DB9 male connector; refer to the following figure for the pin assignment of the interface:

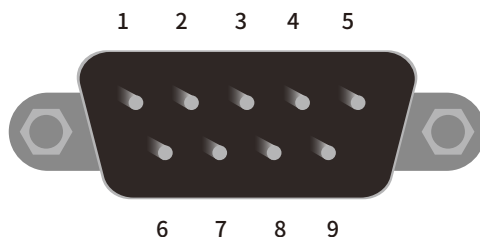

Pin number	Pin name	Pin description	Signal level	Direction
1		None		
2	RXD	Receive Data	RS-232	Input
3	TXD	Transmit Data	RS-232	Output
4		None		
5	GND	Ground	Ground	Ground
6		None		
7		None		
8		None		

### ➤ 2.1.3 Reset/restore export settings button

- When you need to restart or restore the export settings, you can press the RST/INIT button when the device is running normally, press it for less than 1s and then release it, the device will restart; press it for more than 5s and then release it, the device will restore the export settings.

### ➤ 2.1.4 Web interface

- 10Base-T/100Base-TX adaptive Ethernet RJ45 connector, which supports automatic MDI/MDI-X connection; refer to the figure below for the RJ45 connector pin distribution:

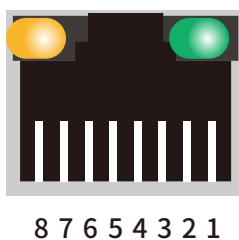

Pin number	Signal name
1	send data+( TD+ )
2	send data-( TD- )
3	Receive data+( RD+ )
6	Receive data-( RD- )
4、5、7、8	Unused



➤ 2.1.5 Status indicator

Indicator light	status	Definition
PWR	Red	Steady on indicates that the power supply is normal, and off indicates that there is no power supply or the power supply is abnormal.
Run	Green	Flashing indicates that the device is operating normally, flashing once every 0.5s; always on or off indicates that the device is operating abnormally.
Link	Green	Steady on means that it is connected to the router in Client mode or other devices are connected in AP mode, or connected to other devices through a wire; off means there is no wireless device connected.
TX/RX	Green	Blinking means RS-232/485/422 interface has data transmission; off means there is no data transmission.

➤ 2.1.6 Antenna

- A 2.4G Wi-Fi antenna.

2.2 Installation size

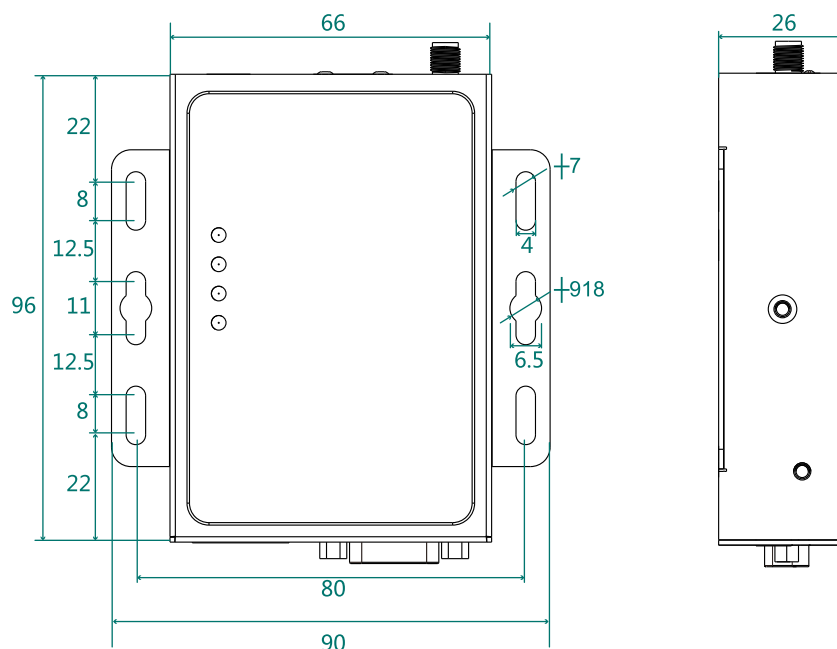

Mport3101-W size(unit: mm)

## Chapter 3 Fast networking

### 3.1 Environmental preparation

WiFi serial server for fast networking, you need to prepare a PC computer or wireless notebook, one Mport3101-W WiFi serial server, one network cable, one DC12V/1A power supply, and the hardware connection is shown in Figure 1.

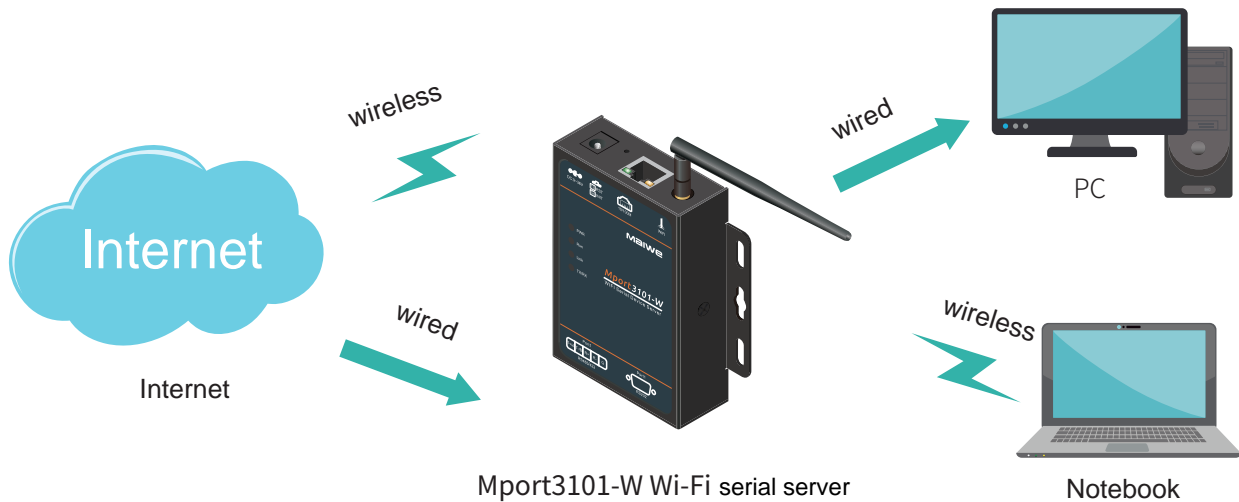

Figure 1 Hardware connection

### 3.2 Internet connection

- Connect the Wi-Fi antenna to the corresponding antenna interface of the WiFi serial server;
- The factory default wireless device is AP mode, and the network port works in WAN mode by default;
- Use DC12V power supply to power on the WiFi serial server;
- Power on and wait for about 30S, the Run light flashes, indicating that the Wi-Fi serial server has been initialized;
- If you use a wireless connection device, you can use a PC with a wireless network card to search for the WiFi hotspot of the device (the Wi-Fi hotspot can be searched in AP mode or AP+Client mode, there is no hotspot in Client mode, and the hotspot name is Mport3101-W by default. -XXXX, XXXX are the last 4 digits of the device's LAN port MAC address), select the corresponding hotspot and set it to automatically obtain IP mode, enter the password (the factory default is www.maiwe.com and click connect to quickly access it;
- After the connection is successful, you can Get an IP of 192.168.16.XXX, PC browser can access 192.168.16.253 to log in to the web interface of the device;

If you use wired access, use a network cable to connect your computer to the Wi-Fi serial server Ethernet port, and the device will automatically use the default IP (the default IP is only used when the factory network port is in WAN mode and DHCP protocol. After the network cable is connected, wait about 15 seconds. Wait until the PC uses the default 169.254.XXX.XXX IP. The default IP of the device is 169.254.173.207, which is usually fixed to this default IP. When there is an IP conflict, it will be automatically replaced with another IP), and PC browser access The default IP can log in to the web interface of the device.

# Chapter 4 WEB basic function configuration

Table 1 Initial value configuration parameter table

Parameter	Initial value
SSID	Mport3101-W-XXXX
Wireless password	www.maiwe.com
LAN port IP address	192.168.16.253
Username	admin
Password	admin

## 4.1 Log in to WEB

Enter IP: 192.168.16.253 in the PC browser (Chrome browser is recommended) to log in, the login interface is shown in Figure 2.

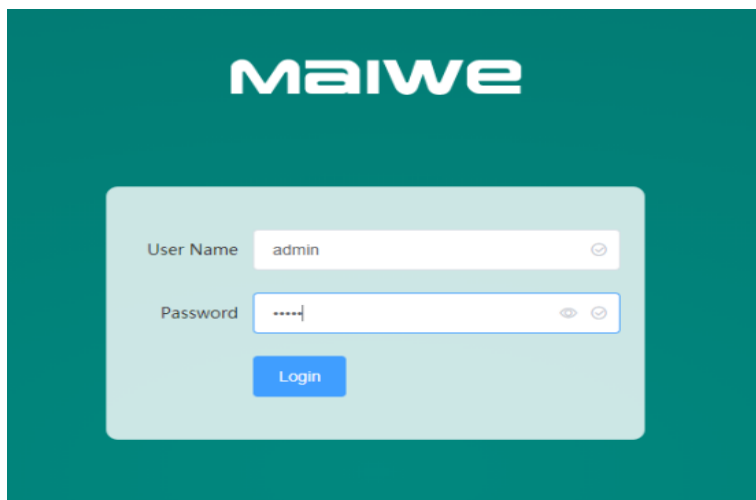

Figure 2 Input user name and password interface

If the user logs in to WEB for the first time, he will enter the novice guide interface (if the user does not want to configure the parameters in the novice guide interface, he can directly click the "X" button in the upper right corner of the interface to exit the novice guide interface), as shown in Figure 3.

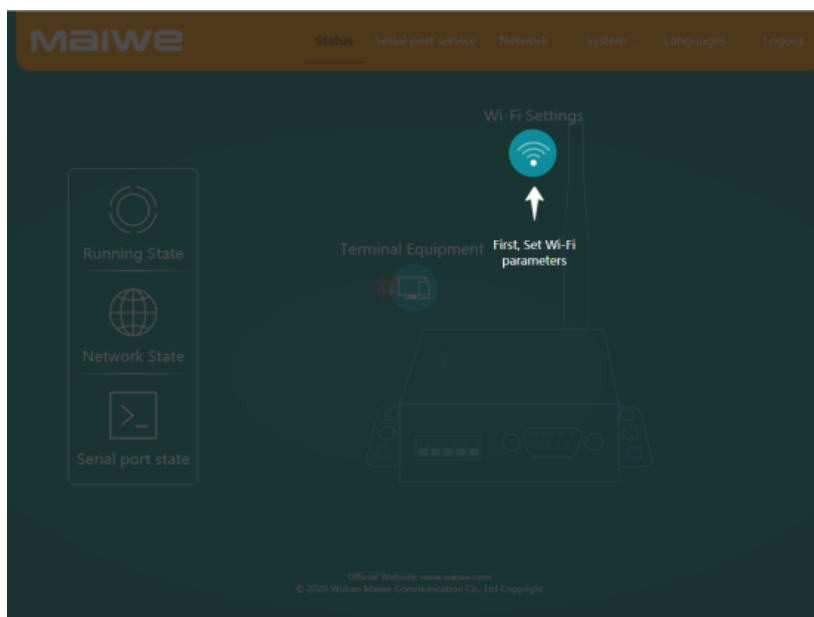

Figure 3 Novice guide page

After completing or exiting the novice guide interface, the system will automatically jump to the main web management page, as shown in Figure 4.

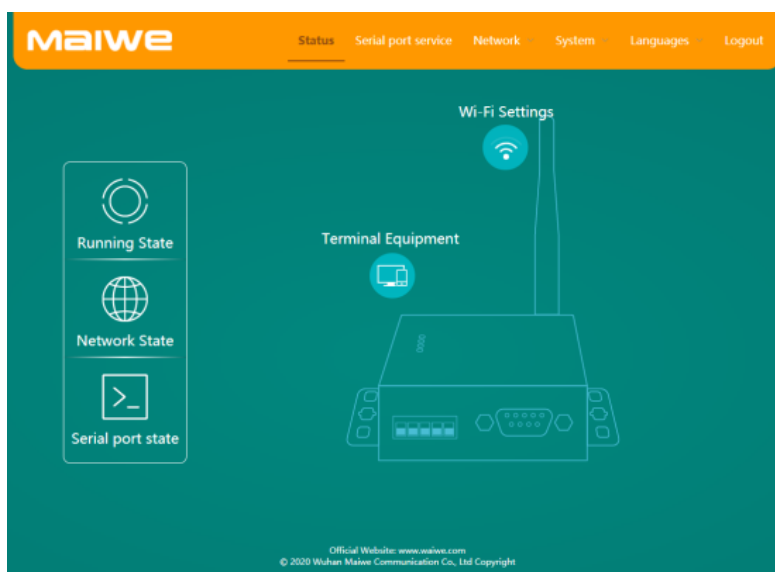

Figure 4 Web management main page

## 4.2 Introduction to the novice guide page

The novice guide interface is shown in Figure 3 above. The main content is the basic Wi-Fi settings. After completion, the system automatically jumps to the main web management interface. The Wi-Fi basic setting interface can set the wireless status, as shown in Figure 5.

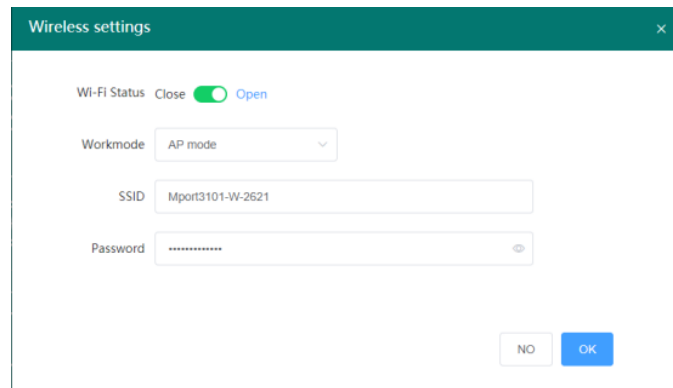

Figure 5 Wi-Fi basic setting interface

## 4.3 Main page introduction

The main interface of Web management is mainly composed of upper and lower areas. The left part of the upper part is the Logo area, and the right is the function menu area; the lower part is the function display and setting area, which can set the functions of the WiFi serial server and Web management. The main interface structure diagram is shown in Figure 6.

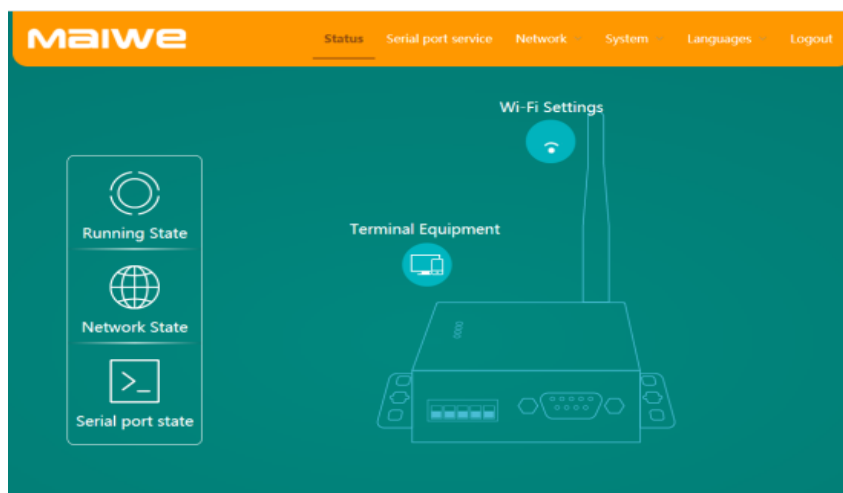

Figure 6 The main interface structure of web management

### 4.3.1 Function menu

The upper right part of the web page is the function menu, which displays all the configurable software functions of this WiFi serial server. The function menu includes status, serial port service, network settings, system settings, language, and exit. Each function menu includes several sub-menu tabs, and the function menu structure is shown in Table 2.

Table 2 Menu function description table

Menu Item	Bookmark	Page function
Status	Operating status	Display device information and running time, such as: device model, device code, firmware version, running time
	Network status	Display MAC address, IP address, subnet mask, gateway, Wi-Fi mode, Wi-Fi status
	Serial port status	Display network mode, receive bytes, send bytes
Serial port service		Set network, serial port, heartbeat package, registration package parameters
Network settings	Wireless setting	Set the basic parameters of wireless and the basic parameters of wireless security
	WAN port settings	Configure the mode of the Ethernet port and basic information when used as a WAN port
	LAN port settings	Basic information and DHCP service when configuring Ethernet port as LAN port
	Access device	Display the terminal equipment connected to the Wi-Fi serial server
	Static routing	Configure static routing table
	Network diagnosis	Network diagnosis
	Port forwarding	Set Wi-Fi serial server forwarding rules
	Restriction of visit	Set IP, MAC and domain name filtering parameters
	UPnP	Turn on and off the UPnP function, and view the UPnP device connection information
System settings	System properties	Display and set the system time, host name and time zone
	Management right	Modify the administrator password and manage common user information
	Reboot	Configure the device to restart immediately and scheduled restart function
	Backup/upgrade	Backup or import configuration files, upgrade system firmware
	Scheduled Tasks	Manually add device scheduled task function
	Log	Configure remote log and local log information, and view and download system logs
	SNMP settings	Configure setting information, community, trap and other parameters
	Alarm settings	Configure email alert related parameters
Language selection	Chinese	Switch the web interface language to Chinese
	English	Switch the web interface language to English
Drop out		Log out

## 4.4 Status

The status module includes: running status, network status and serial port status.

### 4.4.1 Running status

The running status includes the device model, device code, firmware version, and running time, as shown in Figure 7.

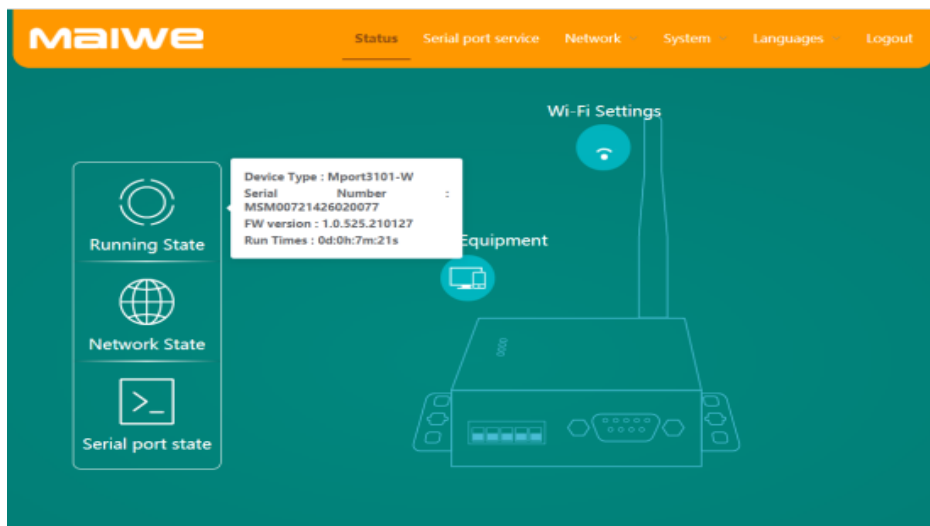

Figure 7 Running status

Device model	Wi-Fi serial server device model
Equipment number	The device number of the WiFi serial server when it leaves the factory
Firmware version	The firmware version number of the WiFi serial server
Operation hours	The current continuous running time of the Wi-Fi serial server

### 4.4.2 Network status

MAC address	The MAC address of the Wi-Fi serial server
IP address	The IP address of the Wi-Fi serial server
Subnet mask	The current subnet mask of the Wi-Fi serial server
Gateway	The current gateway of the Wi-Fi serial server
Wi-Fi mode	Wi-Fi working mode
Wi-Fi status	Wi-Fi connection status

### 4.4.3 Serial port status

Network mode	Wi-Fi serial server network mode
Receive byte	The number of bytes received by the serial port of the Wi-Fi serial server
Send byte	The number of bytes sent by the serial port of the Wi-Fi serial server

## 4.5 Serial Port Service

Serial port service module includes: network, serial port, heartbeat package, registration package and Modbus function usage.

### 4.5.1 Internet

Mport3101-W WiFi serial server can convert serial data into TCP/IP network data, realize the two-way transparent transmission of serial port and TCP/IP network interface data, and facilitate the networking of serial devices. The serial port service interface includes four parts: network, serial port, heartbeat package, and registration package. The network parameter configuration page is shown in Figure 8.

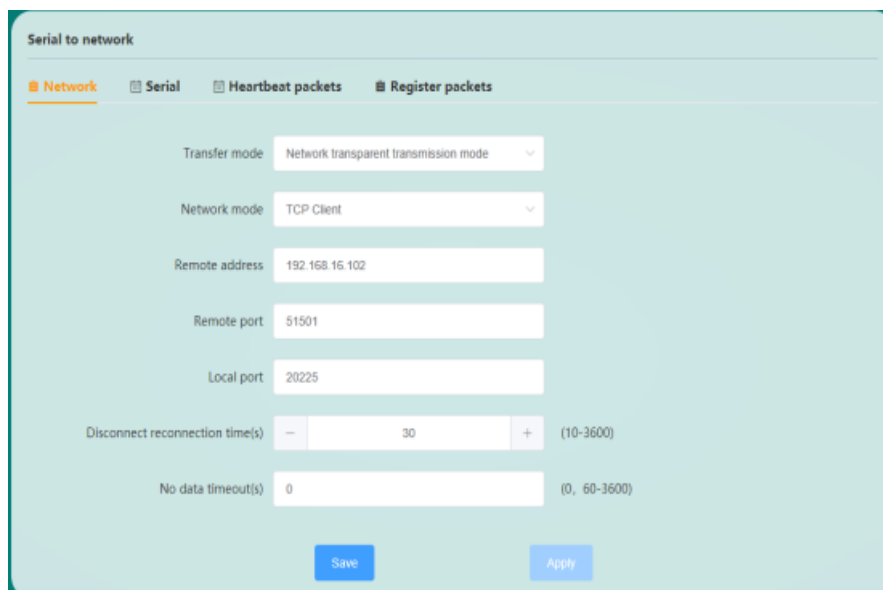

Figure 8 Network parameter configuration page



Transmission mode	The method of data transmission, currently supports serial data transparent transmission mode
Network mode	The module has 8 transparent transmission network working modes, namely TCP Client, TCP Server, UDP Client, UDP Server, Modbus RTU Master, Modbus RTU Slave, Modbus ASCII Master, Modbus ASCII Slave
Remote address	When the module works in Client or Master mode, the remote address is the IP address or domain name of the Server
Remote port	When the module works in Client or Master mode, the remote port is the port number of Server
Local port	Local port number when the module is working
Disconnect and reconnect time	When the device receives the Socket disconnect request sent by the server, it waits for the set time before trying to connect again, the unit is seconds
No data timeout	When set to 0, the no data timeout reconnection function is disabled: When set to 60~3600, the device will actively disconnect from the server after the time that the device cannot receive data from the network reaches the set time, and re-initiate the connection . This function can prevent abnormal socket disconnection and cause the device to stay in a false connection state for a long time. The unit is seconds

### 4.5.2 Serial port

The serial port page displays RFC2217, baud rate, data bit, stop bit, parity bit, packing time, packing length, total number of receptions and total transmissions, as shown in Figure 9.

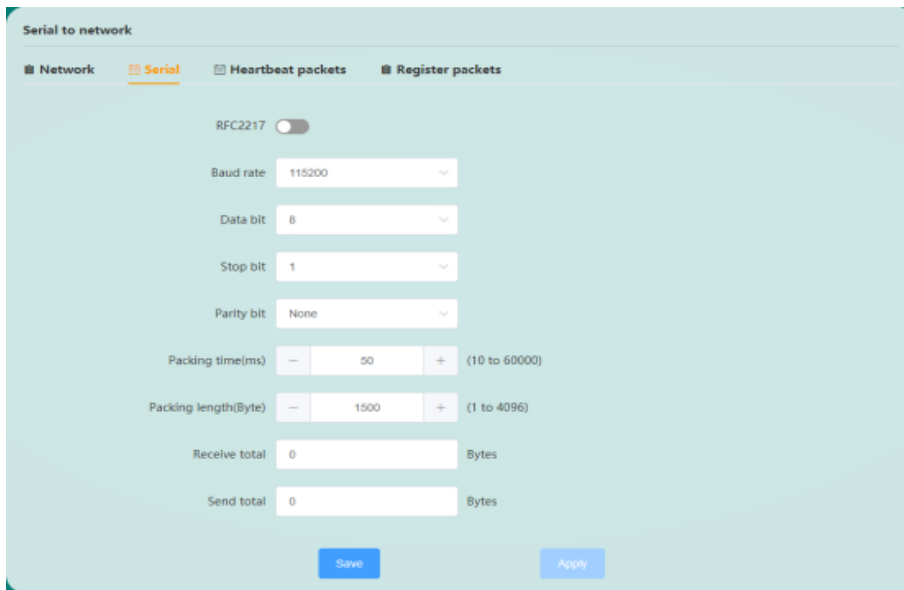

Figure 9 Serial port parameter configuration page

RFC2217	RFC2217 enable control
Baud rate	The baud rate of serial communication, the unit is bps
Data bit	Set the effective number of data bits in serial communication
Stop bit	Set the length of the stop bit during serial communication
Check Digit	There are three options for checking, including no check, odd check and even check
Packing time	When the time interval for the device serial port to receive adjacent data is greater than the set value, it is considered that a frame is over, and this frame of data is packaged and sent to the network. The unit is milliseconds
Packing length	During the packing time, when the length of the data received by the device serial port is greater than the set packing length, the received data will be immediately packaged and sent to the network. Unit is byte
Receive byte	Number of bytes received by the serial port
Send byte	Number of bytes sent by serial port

### 4.5.3 Heartbeat package

A heartbeat packet refers to a custom command word that regularly informs the other party of its own state during the client and service period, and is sent at a certain time interval, as shown in Figure 10.

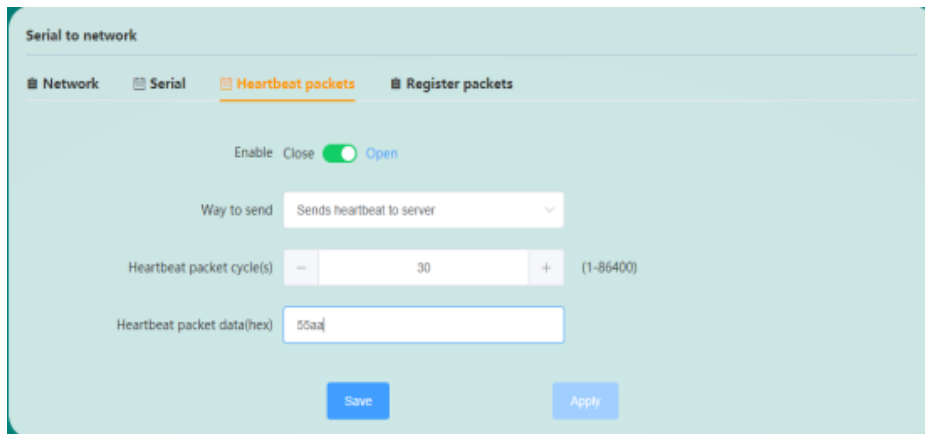

Figure 10 Heartbeat packet configuration page

Turn on	Heartbeat packet status
Sending method	Including sending heartbeat to serial port terminal and sending heartbeat to server
Heartbeat cycle	The time interval for the module to send heartbeat packet data to the serial port terminal or server
Heartbeat packet data	The content of the data sent by the module to the serial port terminal or server (currently supports hexadecimal format). Take the module working in TCP Client mode as an example, the remote address is set to the IP of the PC, and the port number is 20225 by default. Then turn on the heartbeat packet, select the sending method as "send heartbeat to the server", set the heartbeat packet period to 5 seconds, and set the heartbeat packet data to hexadecimal 55aa. Then set up a TCP Server on the PC to view the server receiving data, as shown in Figure 11.

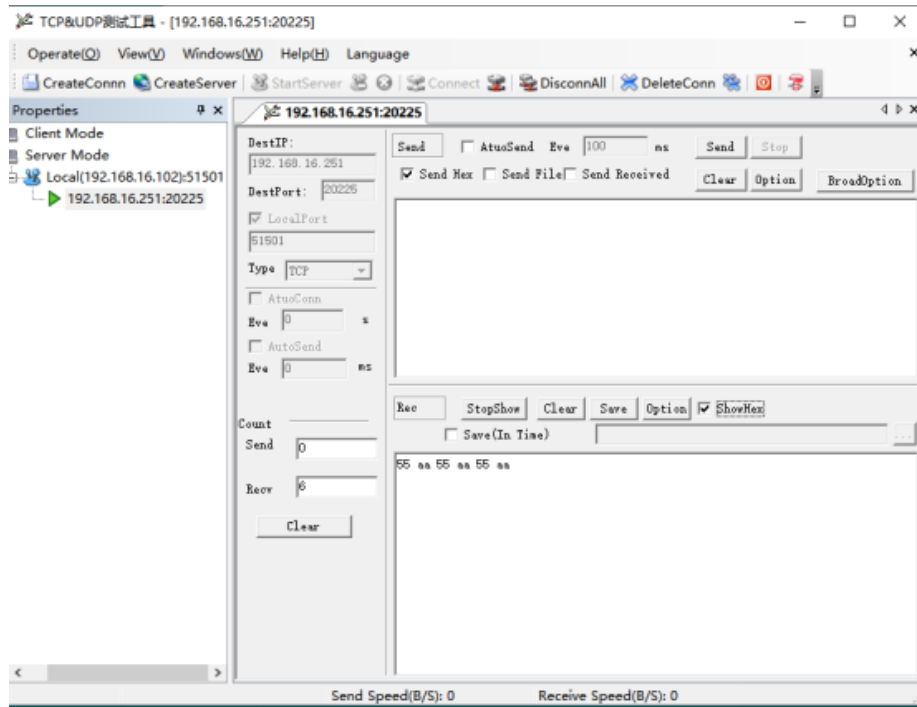

Figure 11 TCP Server receives heartbeat data

### 4.5.4 Registration package

The registration package is to allow the server to identify the data source device, or as a password to obtain server function authorization, as shown in Figure 12.

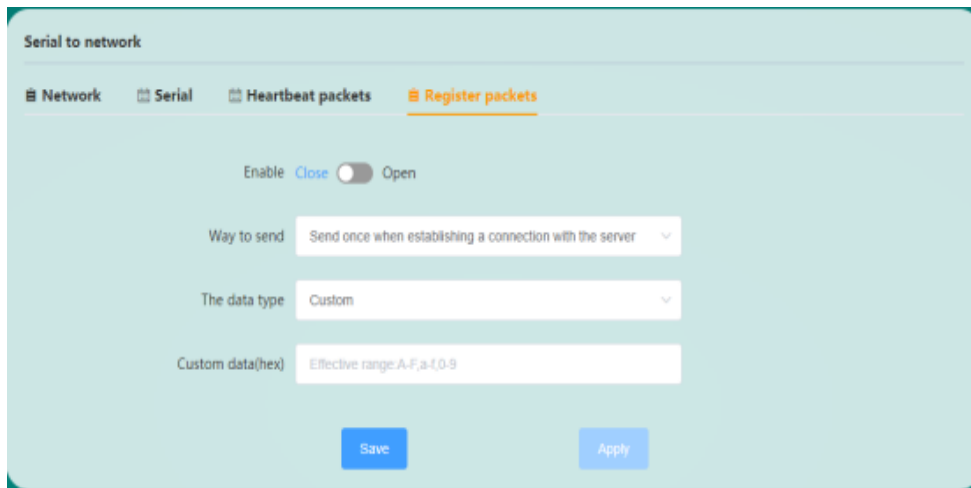

Figure 12 Registration package configuration page

Turn on	Status of the registered package
Sending method	The registration package sending data is divided into two methods: sending once when establishing a connection with the server and adding a registration package before each frame of data
Type of data	Data type is custom way
Custom data	Enter the content of the data to be sent (currently supports hexadecimal data format), as shown in Figure 13

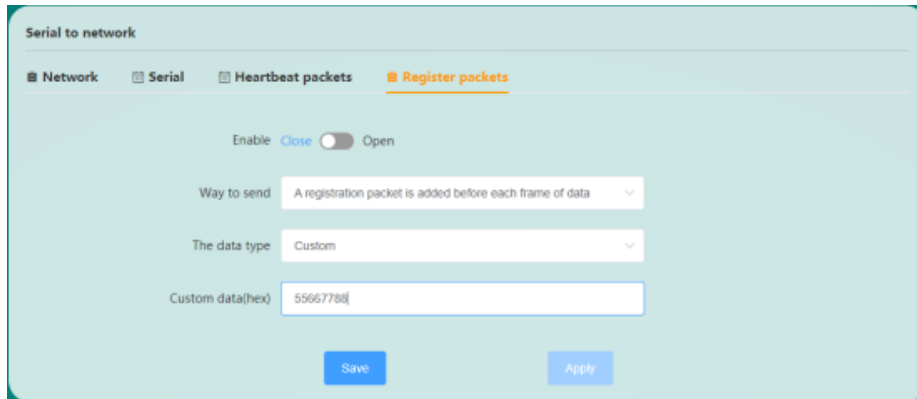

Figure 13 Registration package custom data

## 4.5.5 Modbus function usage

Simulate the master with software such as Modbus Poll, and simulate the slave with software such as Modbus Slave.

### 4.5.5.1 Modbus Master

Take Modbus\_RTU\_Master as an example (Modbus ASCII Master is the same):

Configure the "serial port parameter" of the serial server to 9600-8-N-1, the working mode in "network parameters" is Modbus RTU Master, and the network address in "Network Connections" is configured as the IP and port of the slave. The physical connection is described as follows:

Serial port: connect to the host.

Network port: connect to the slave.

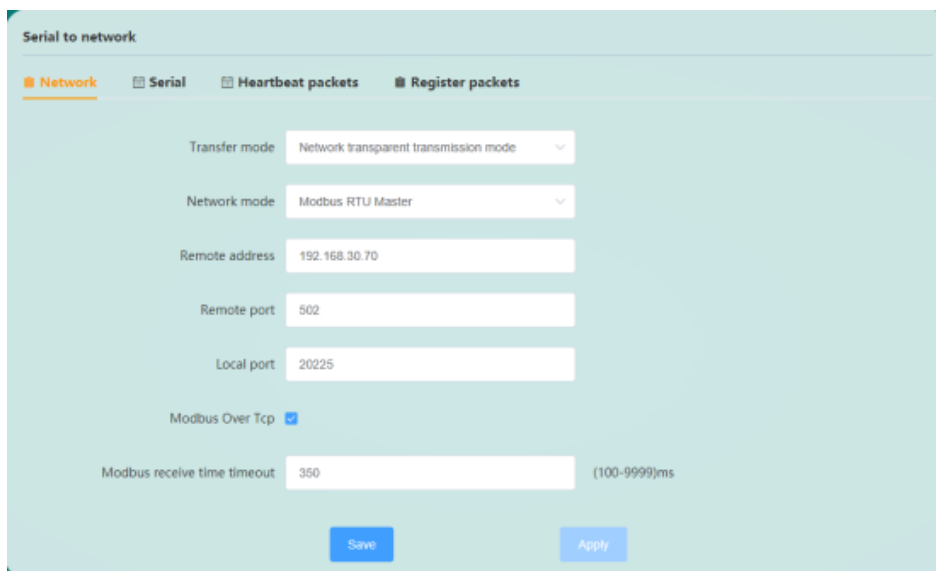

Figure 14 Modbus Web parameter configuration

Modbus Poll software configuration:

Open the Modbus Poll software, go to "Connect" -> "Connect", and the connection parameters are configured as follows:

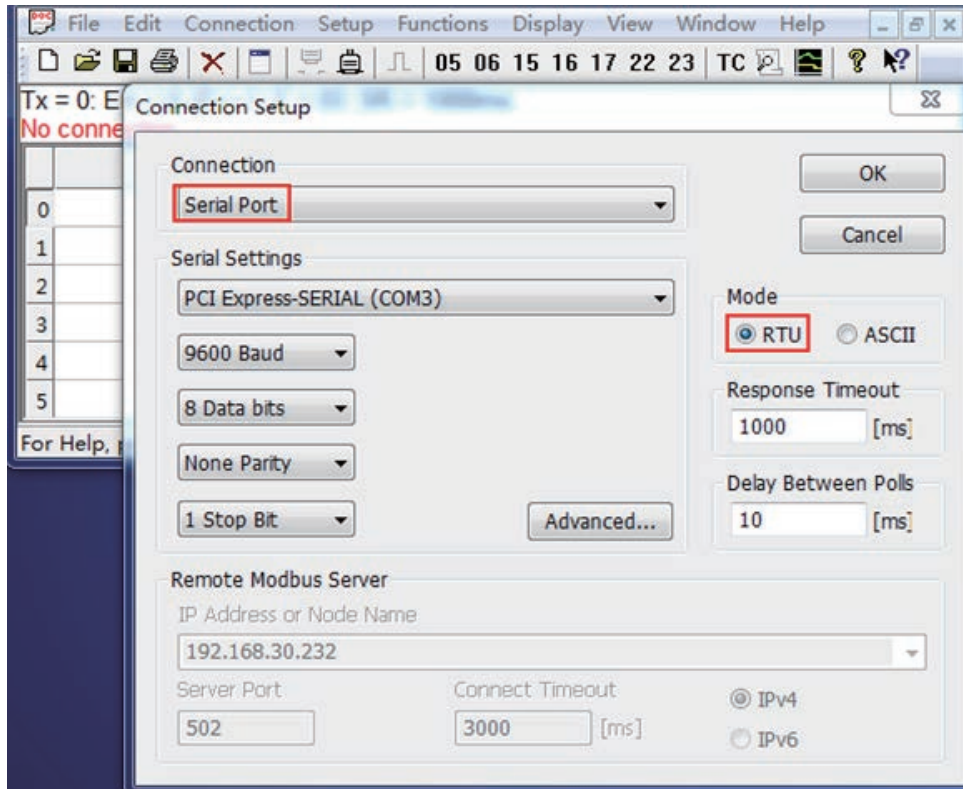

Figure 15 Modbus host serial port parameter configuration

Read parameter configuration: the slave ID is 1, the function code is 03, the starting address of the register to be read is 0, the number of registers to be read is 10, and the cycle reading interval is 1000ms.

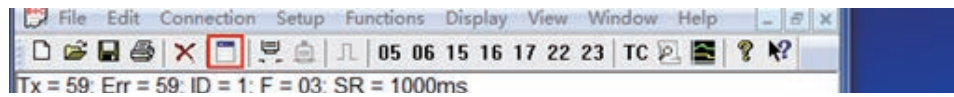

Figure 16 Modbus host device attribute definition

Open Modbus Slave software: Go to "Connect" -> "Connect", and the connection parameters are configured as follows:

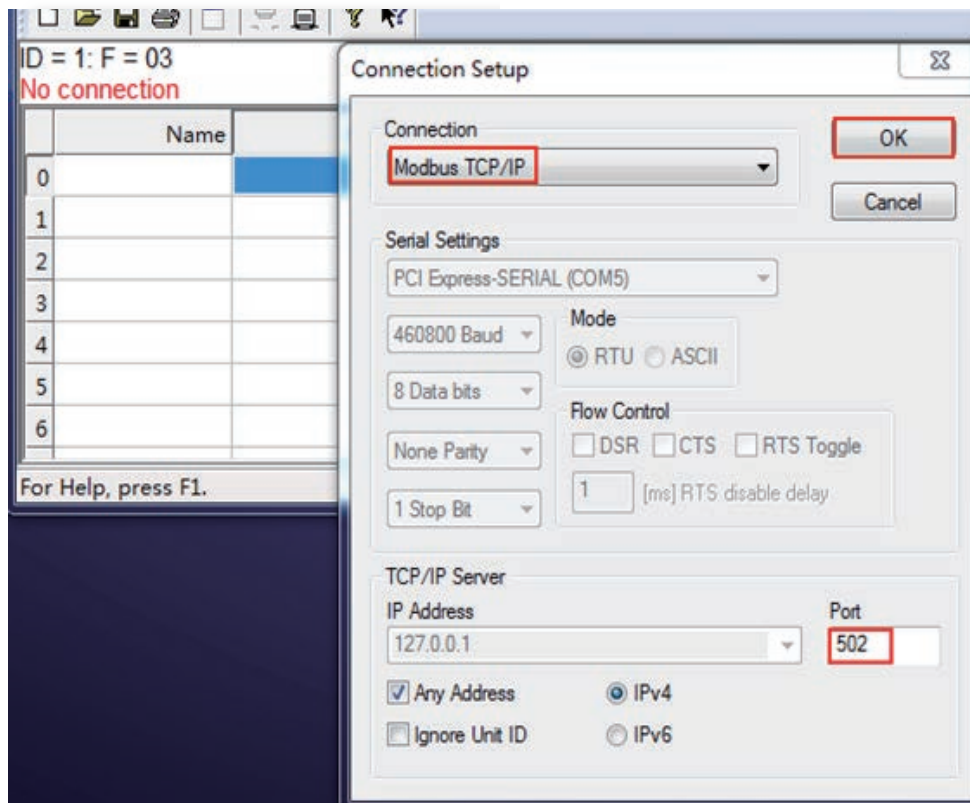

Figure 17 Mosbus slave network connection configuration

Slave device definition configuration: the slave ID is 1, the function code is 03, the register start address is 0, and the total number of registers is 200.

Figure 18 Modbus slave device attribute definition

Double-click the cell of Modbus Slave software and modify it to auto-increment mode, you can see that the register cell of Modbus Poll software also changes value automatically. Indicates that the device communication is normal.

Figure 19 The value of Modbus slave register is automatically incremented

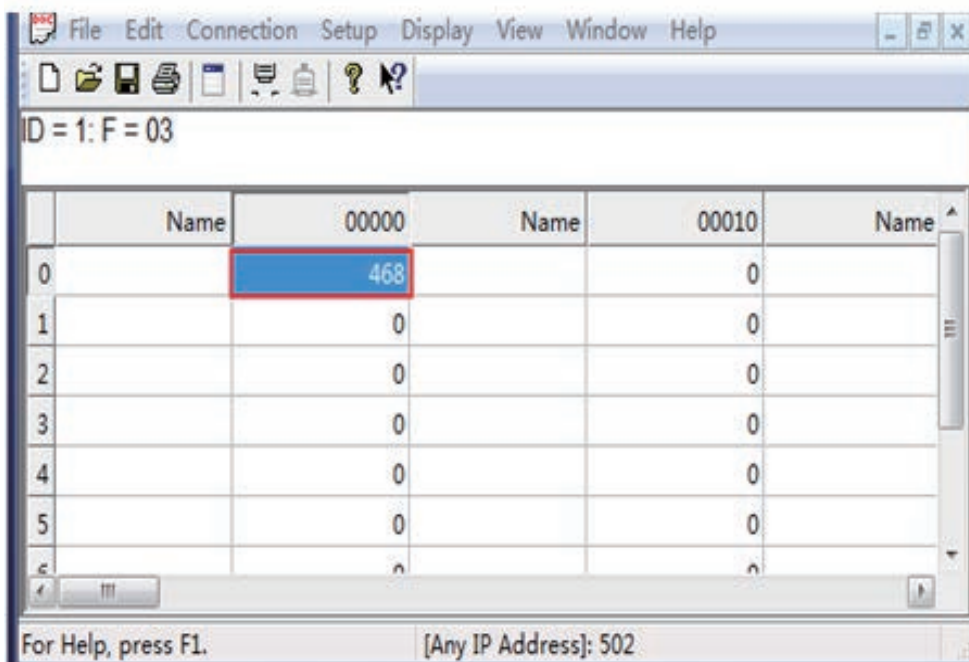
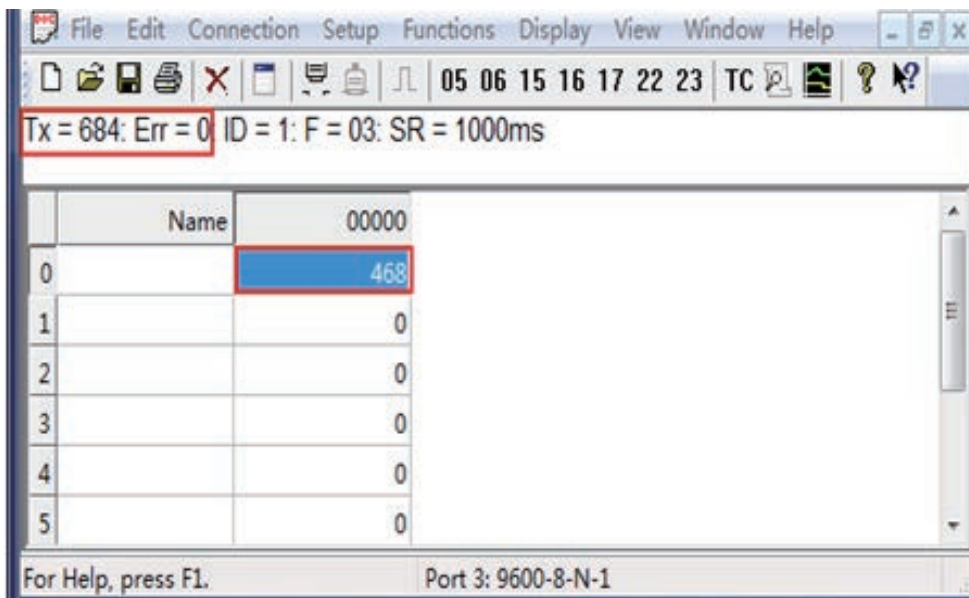

Figure 20 Communication is normal, the host can read the register data of the slave through the serial server device

### 4.5.5.2 Modbus Slave

Take Modbus\_RTU\_Slave as an example (the same applies to Modbus ASCII Slave):

Configure the "serial port parameter" of the serial server to be 9600-8-N-1, the working mode in the "network parameter" is Modbus RTU Slave, and the local port is 502. The physical connection is described as follows:

Serial port: connect to the slave.

Network port: connect to the host.

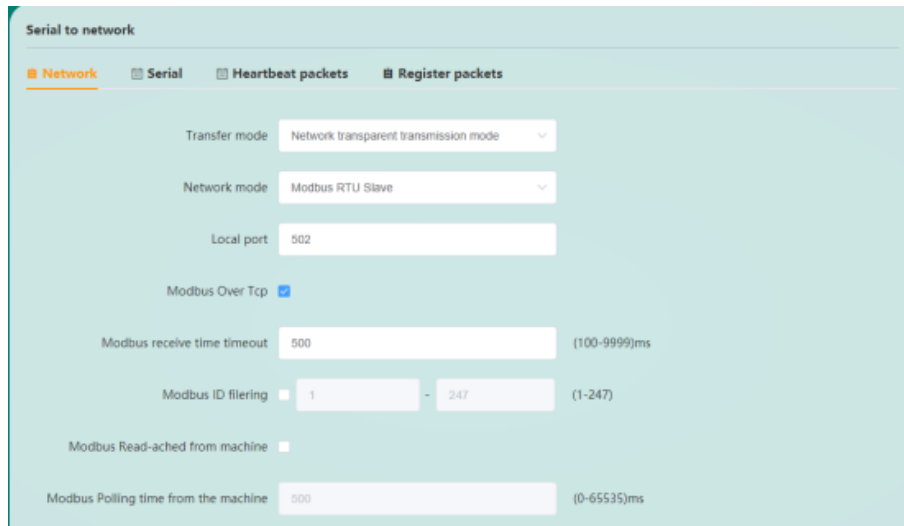

Figure 21 Modbus Web parameter configuration

Open Modbus Poll software: Go to "Connect" -> "Connect", and the connection parameters are configured as follows:

Figure 22 Modbus host network connection parameter configuration



Read parameter configuration: the slave ID is 1, the function code is 03, the starting address of the register to be read is 0, the number of registers to be read is 10, and the cycle reading interval is 1000ms.

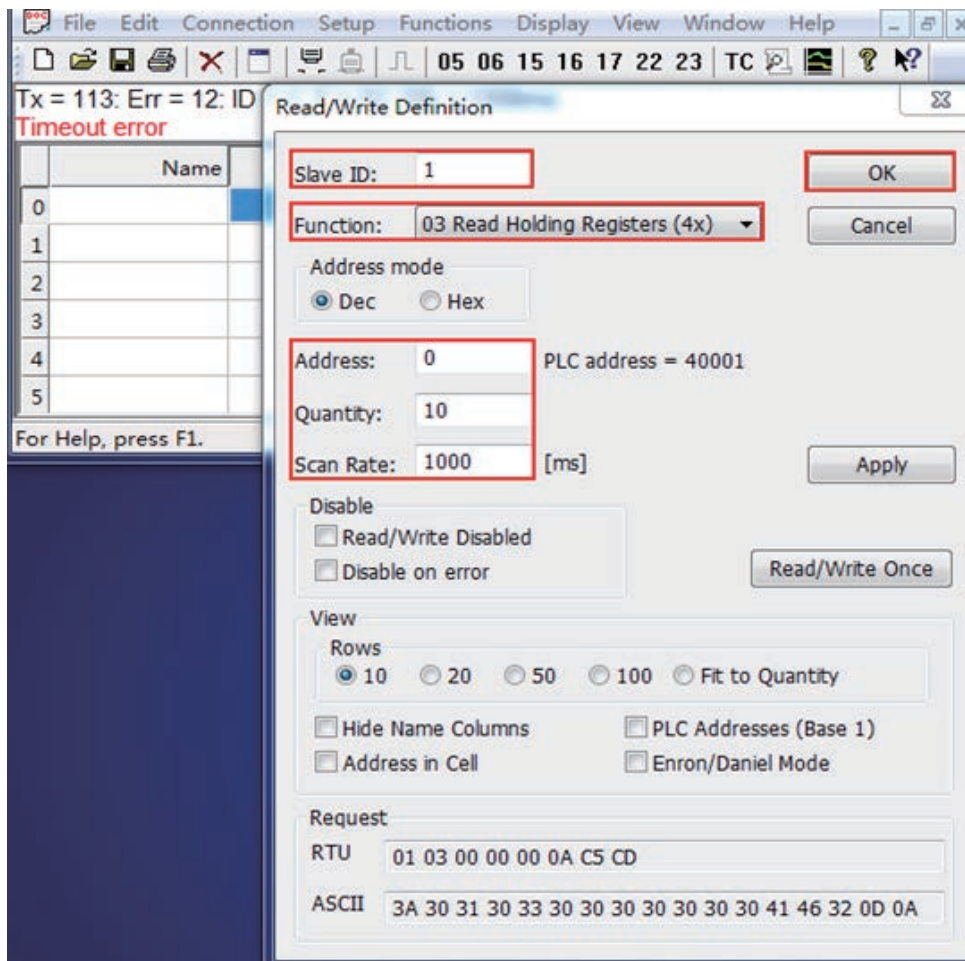

Figure 23 Modbus host device attribute definition

Open Modbus Slave software: Go to "Connect" -> "Connect", and the connection parameters are configured as follows:

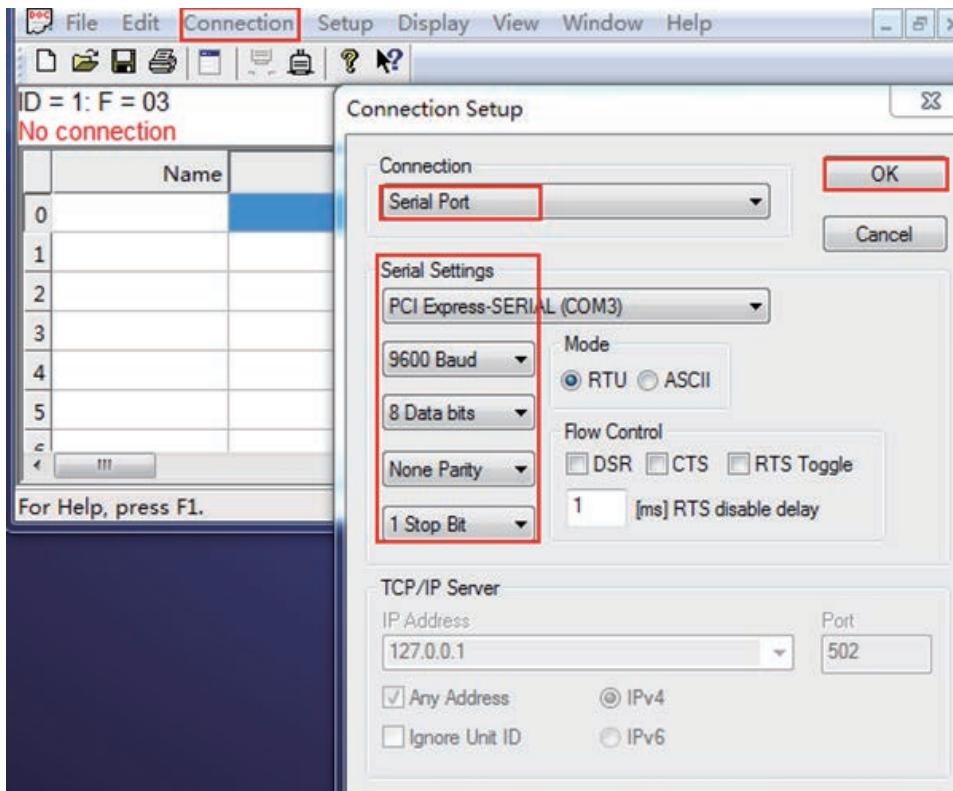

Figure 24 Modbus slave serial port parameter configuration

Slave device definition configuration: the slave ID is 1, the function code is 03, the register start address is 0, and the total number of registers is 200.

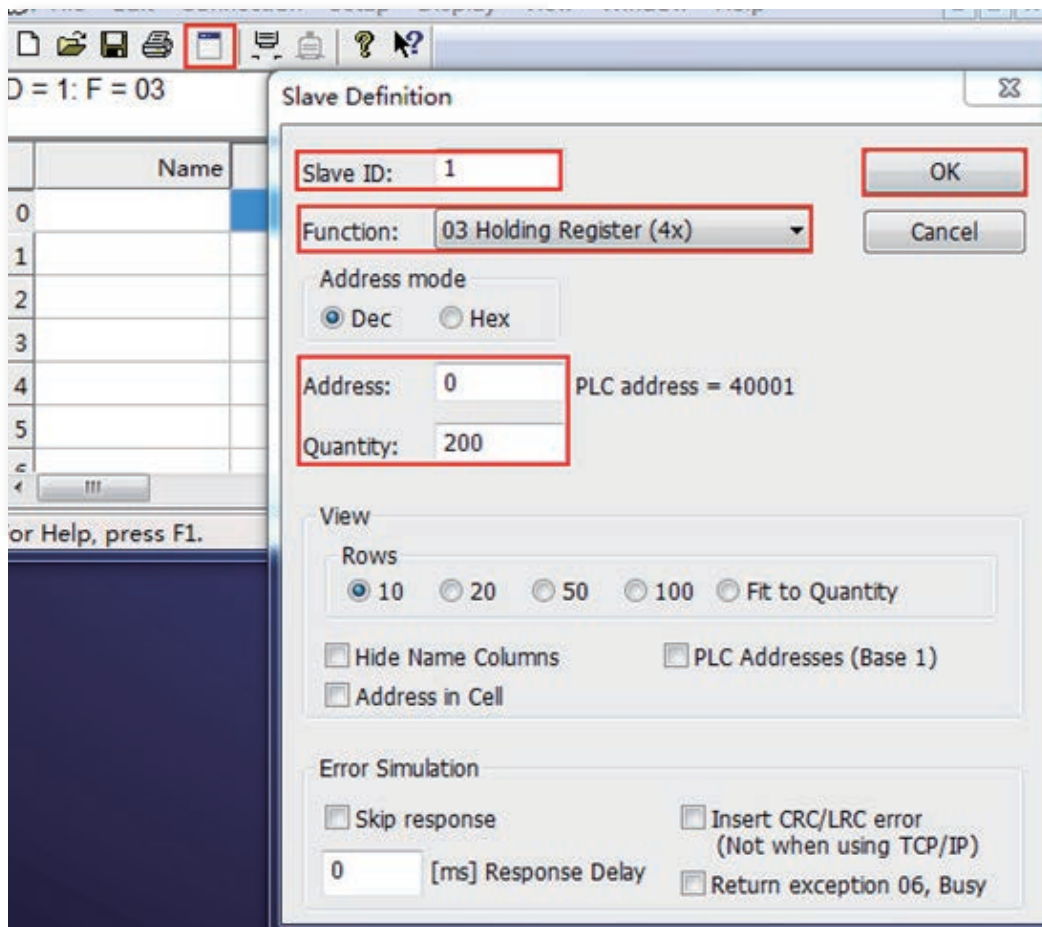

Figure 25 Modbus slave device attribute definition

Double-click the cell of Modbus Slave software and modify it to auto-increment mode, you can see that the register cell of Modbus Poll software also changes value automatically. Indicates that the device communication is normal.

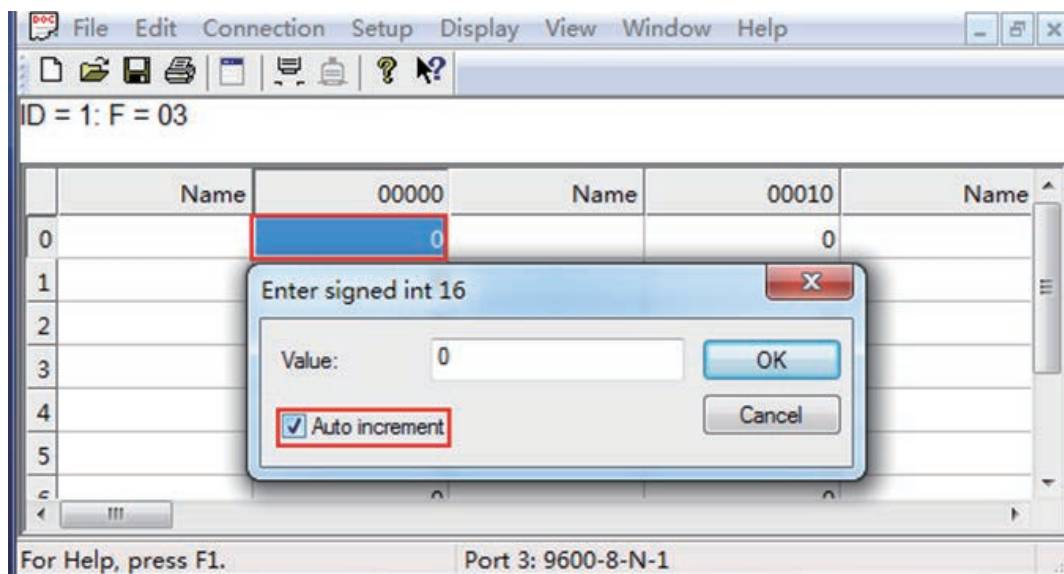

Figure 26 The value of Modbus slave register is automatically incremented

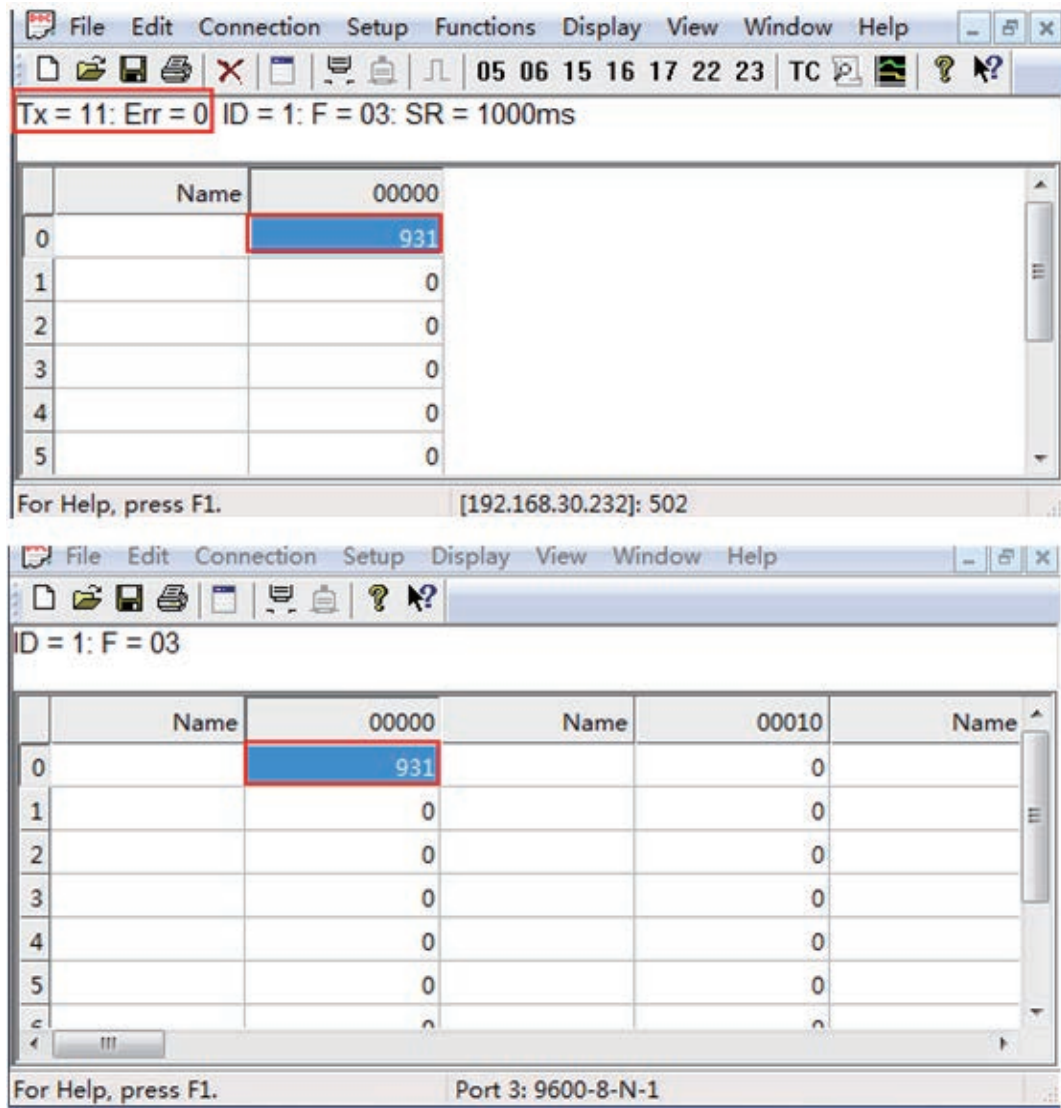

Figure 27 Communication is normal, the host can read the register data of the slave through the serial server device

**Caution**

1. The device and the remote device must have the same baud rate, parity bit, data bit and stop bit,
2. If the working mode of the device is UDP, the remote device must also work in UDP mode; if the working mode of the device is TCP\_Client, the remote device must work in TCP\_Server mode; if the working mode of the device is TCP\_Server, the remote device must work in TCP\_Client mode;
3. When you need to use long frame data frequently or have high data transmission requirements, please adjust the baud rate and lengthen the sending interval appropriately to prevent the slow serial port from causing messy codes or packet loss.
4. When configuring the device, the user should ensure that the external RS-232/RS-485/RS-422 device stops sending data to the serial server to avoid garbled characters;
5. When Modbus\_ASCII\_Master turns on the transparent transmission mode, it only supports reading of up to 60 registers
6. Affected by the serial port rate, when Modbus data times out, you should configure the appropriate modbus receiving timeout time on the web. At the same time, the read timeout time of the host computer should be appropriately extended according to the baud rate.

## 4.6 Network settings

The network setting module includes: wireless setting, WAN port setting, LAN port setting, access device, static routing, network diagnosis, port forwarding, access restriction, UPnP.

### 4.6.1 Wireless setting

Mainly used to display basic wireless information, wireless AP settings are shown in Figure 28.

The screenshot shows the 'Wi-Fi Settings' interface. At the top, there is a 'Wi-Fi Status' section with a toggle switch set to 'Open'. Below this is a 'Workmode' dropdown menu set to 'AP mode'. The 'AP mode settings' section includes several fields: 'SSID' (Mport3101-W-2621), 'Network Model' (802.11b/g/n), 'Channel' (auto), and 'Frequency Bandwidth' (20MHz). There is also an 'SSID Hide' toggle switch set to 'Close'. The 'Encryption' is set to 'WPA2-PSK' and the 'Algorithm' is set to 'Enforce CCMP(AES) encry'. A 'Password' field is present with masked characters. At the bottom, there are 'Save' and 'Apply' buttons.

Figure 28 Wireless AP configuration page

This page can set wireless parameters such as SSID, and can also modify the encryption method and password. The legal value length of the wireless password is 8-32 bytes, and it can only include numbers, letters and special symbols (~!@#%^&\*()\_+-).

The wireless client settings are shown in Figure 29.

The screenshot shows the 'Wi-Fi Settings' interface for Client mode. At the top, there is a 'Wi-Fi Status' section with a toggle switch set to 'Open'. Below this is a 'Workmode' dropdown menu set to 'Client mode'. The 'Client mode settings' section includes an 'Access networks' field with a 'Search' button, an 'encryption' dropdown menu set to 'WPA2-PSK', and a 'Wireless password' field. At the bottom, there are 'Save' and 'Apply' buttons.

Figure 29 Wireless Client configuration page

Click "Search" on the interface to search for a list of surrounding wireless hotspots. The user selects the wireless hotspot he needs to connect to, enters the hotspot password, and the application can connect to the hotspot.

The wireless AP+Client settings are shown in Figure 30.

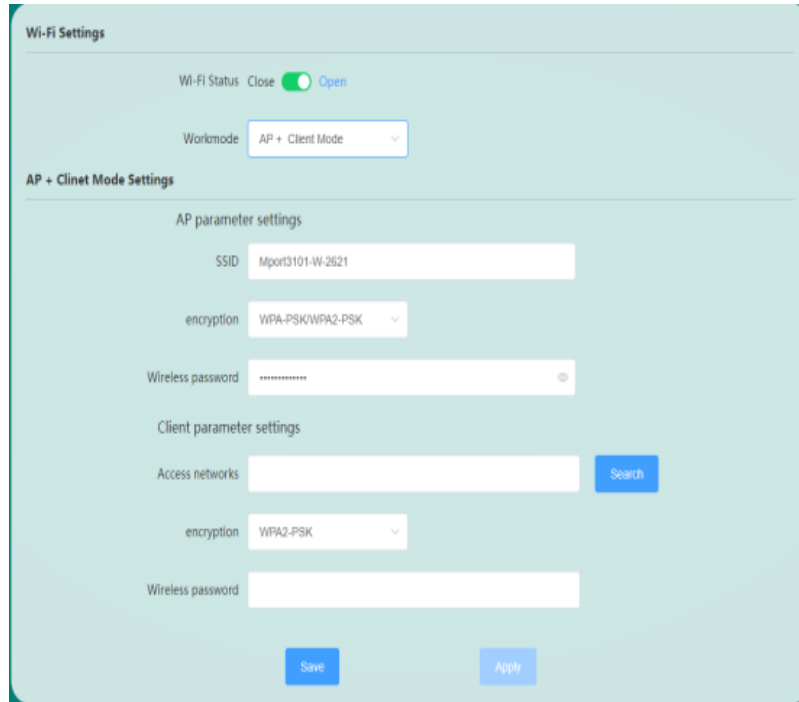

Figure 30 Wireless AP+Client configuration page

This page can set AP and Client parameters at the same time. At this time, the Wi-Fi serial server is both AP and Client.

### 4.6.2 WAN port settings

Used to configure the working mode and protocol parameters of the network port. The working mode is configured as WAN mode at the factory, which is used to connect to the external network. If configured as LAN mode, the network port is used as a normal LAN port. When configured in WAN mode, the WAN port protocol can be divided into three types: static address, DHCP, and PPPoE. The static address protocol is shown in Figure 31, and the PPPoE protocol is shown in Figure 32.

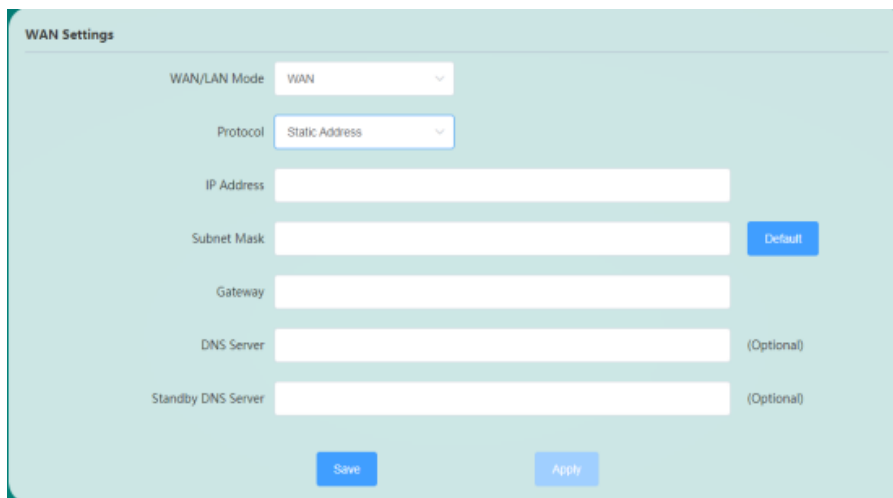

Figure 31 Static address page

WAN/LAN model	Configure the working mode of the network port, the default is WAN mode (used to connect to the external network), if it is configured as LAN mode, the network port is equivalent to the LAN port
Protocol	The currently selected WAN port networking protocol (static address, DHCP and PPPoE)
IP address	The network address assigned to the WAN port of the WiFi serial server
Subnet mask	Used to indicate which bits of an IP address mark the subnet where the host is located, and which bits mark the bit mask of the host. The subnet mask divides the IP address into two parts: the network address and the host address
Gateway	IP address for end users to access other network equipment
DNS server	Used to resolve domain names
Alternate DNS server	Used to resolve domain names

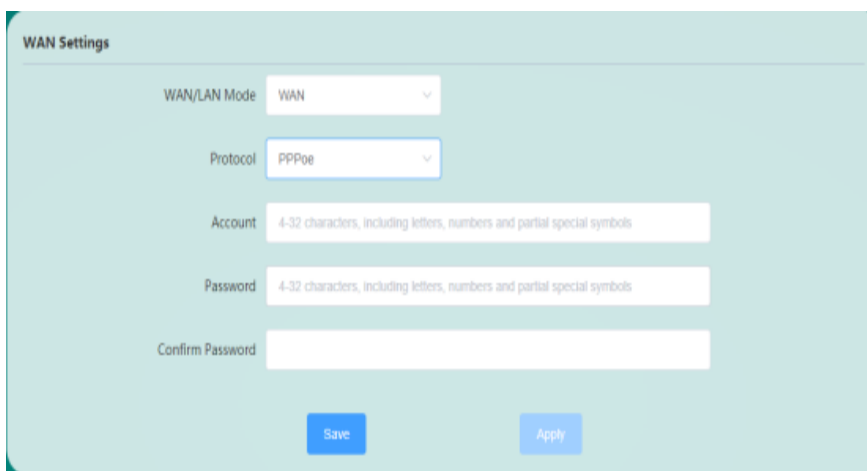

Figure 32 PPPoE protocol interface

Online Account	Enter the Internet account, the length is 4-32 digits, can only include numbers and letters
Internet password	The password length is 4-32 digits and can only include numbers, letters and some special symbols (~!@#\$\$%^&*()_+.-)
Confirm password	Confirm the Internet password in case the password is wrong

### 4.6.3 WAN port settings

It is used to configure the basic information when the network port is configured in LAN mode, as shown in Figure 33.

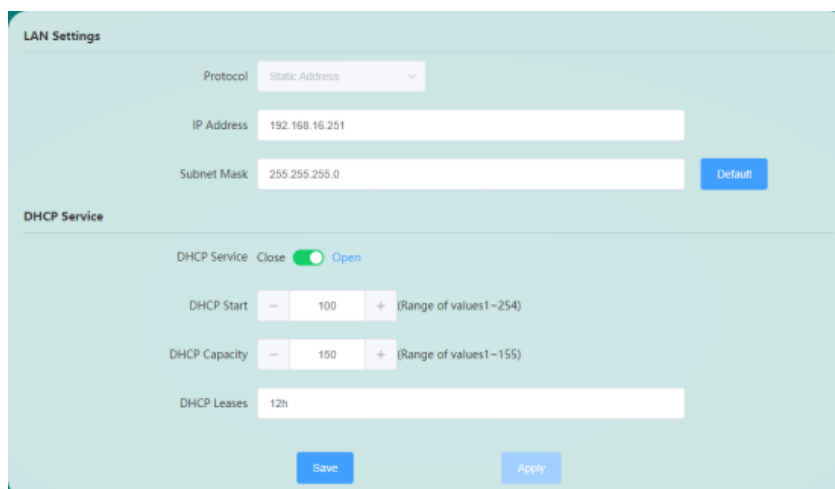

Figure 33 LAN port configuration interface

The detailed description of the configuration parameters of this interface is shown in Table 3.

Table 3 Description of LAND configuration parameters

Project	Description
Basic settings	
Protocol	Default is static address
IP address	The default IP address is 192.168.16.253, which can be modified
Subnet mask	The default subnet mask is 255.255.255.0, which can be modified
DHCP service	
DHCP service	Select the DHCP service, enable or disable it
DHCP start	Set the initial value of DHCP, the value range is 1-254
DHCP capacity	Set the capacity of DHCP, the value range is 1-254
DHCP lease	Set the DHCP lease period, such as 2m(2 minutes), 8h(8 hours) or 5d(5 days), etc.



Caution

When the Wi-Fi serial server LAN port provides DHCP service, it is not allowed to connect the LAN port to other networks with DHCP service enabled. Otherwise, the LAN port device may not be able to obtain correct network information.

### 4.6.4 Access device

Display the list of terminal devices currently connected to the Wi-Fi serial server. As shown in Figure 34.

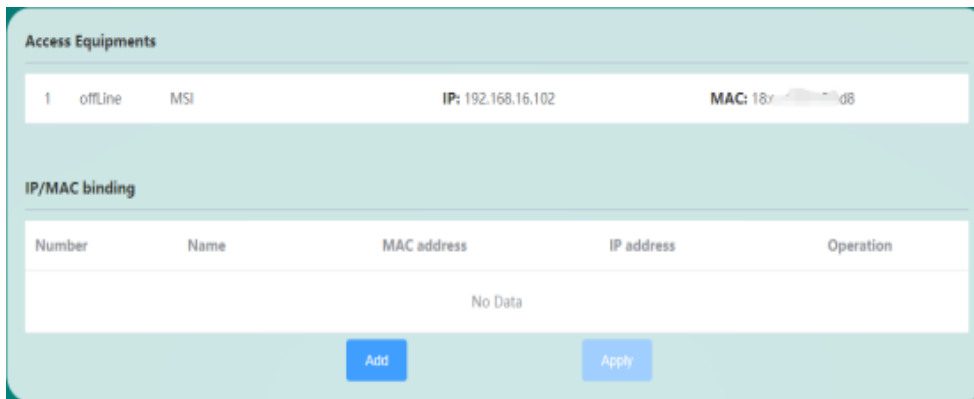

Figure 34 Access device page

The access device only displays the list of devices dynamically allocated by the Wi-Fi serial server DHCP Server (if the device uses a static IP to access the WiFi serial server LAN, you can find the device from the "terminal device" list on the main web management interface) .

IP/MAC binding can be used to specify the IP address dynamically obtained by the LAN terminal device to prevent the IP address assigned by the DHCP Server from changing or conflicting. IP/MAC binding requires the Wi-Fi serial server network port as a LAN port and enable the DHCP Server function.

### 4.6.5 Static routing

You can manually add or modify routing rules through static routing. The static route adding parameters are shown in Table 4.

Table 4 Static routing parameter table

Name	Meaning	Remarks
Interface	Port on which static routing rules are executed	WAN port is selected by default
Destination network	Destination network address or address range to be accessed	Such as 192.168.30.0
Subnet mask	The subnet mask of the destination network to be accessed	255.255.255.0
Gateway	Gateway address to be forwarded to	Such as 192.168.1.102
Hops	Number of packet jumps	Fill in 0 by default

The WiFi serial server does not add any static routing rules by default, and the addition of static routing needs to be configured according to the actual network deployment environment. An example of using static routing is as follows: The network deployment of two WiFi serial server A, B and connected devices T1~T4 is shown in Figure 35.

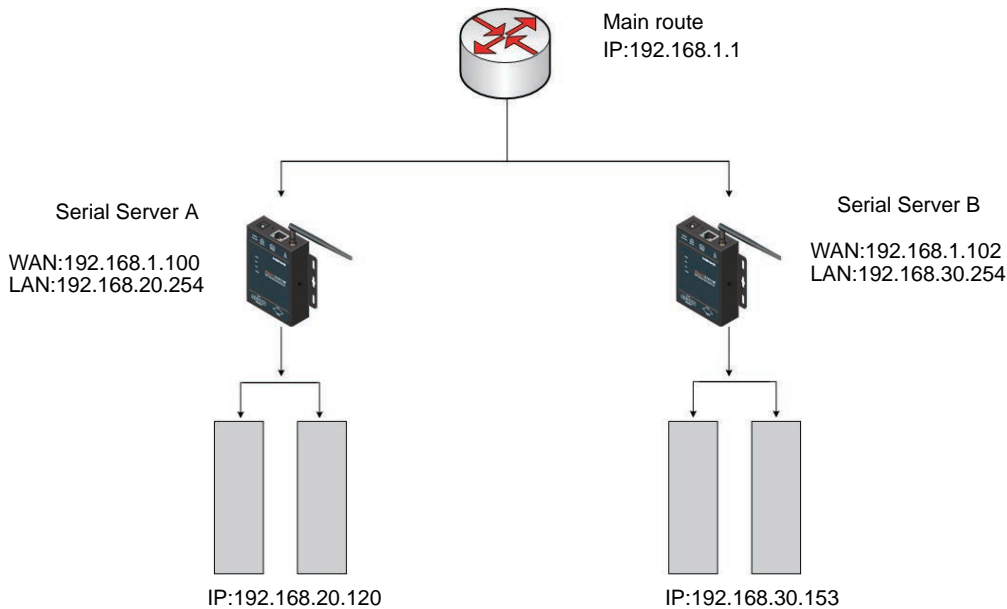

Figure 35 Network connection diagram

The WAN ports of WiFi serial server A and B are connected to the main router 192.168.1.0/24 subnet; set the LAN port IP of WiFi serial server A to 192.168.20.254, and the subnet to 192.168.20.0/24, Set the LAN port IP of Wi-Fi serial server B to 192.168.30.254, the subnet is 192.168.30.0/24, and T1, T2, T3, T4 are connected to the corresponding WiFi serial server through wireless.

If the device T1 wants to access the Wi-Fi serial server B's address 192.168.30.254 through the WiFi serial server A, you need to add a static route on the WiFi serial server A to the WiFi serial server B, as shown in Figure 36.

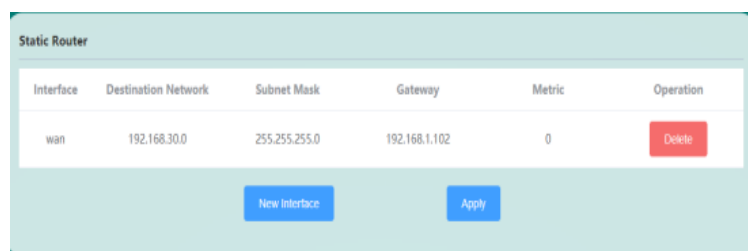

Figure 36 Static routing page



Description

The static routing example above shows that device T1 under WiFi serial server A accesses WiFi serial server B. If you want device T3 under WiFi serial server B to access WiFi serial server A, you need to access WiFi serial server A in the same way. Set up a static route on WiFi serial server B.

### 4.6.6 Network diagnosis

This interface provides simple WiFi serial server network test functions, including Ping diagnosis, TraceRoute, Nslookup query, etc. The diagnosis result of Ping through the WiFi serial server is shown in Figure 37.

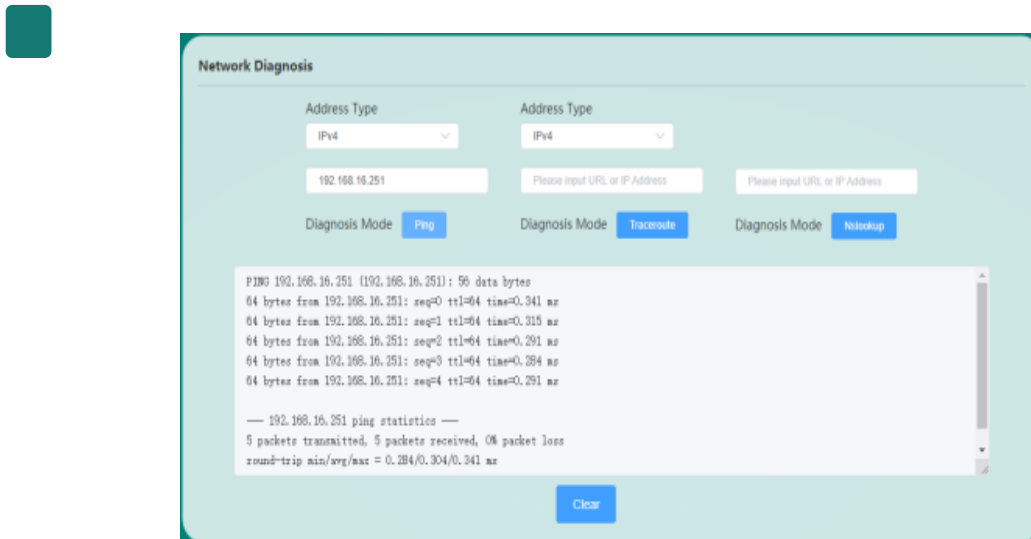

Figure 37 Network diagnosis page

### 4.6.7 Port forwarding

Port mapping forwarding is to map a designated port of the WAN port address to a host in the intranet. If we want to access a device in the LAN from the external network (the WiFi serial server must be accessible by the external network), then we need to set the mapping from the external network to the internal network, for example, set the external network port to 10000 and the internal network IP is 192.168.30.129, and the intranet port is 8848. When we access port 10000 from the WAN port, the access request will be transferred to 192.168.30.129:8848, and the corresponding port forwarding rules are shown in Figure 38.

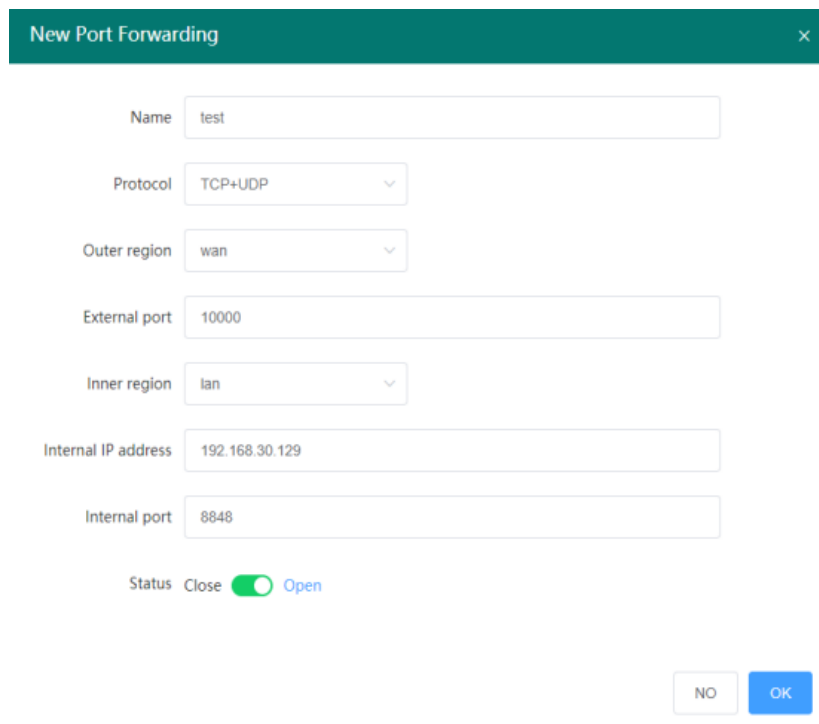

Figure 38 New port forwarding page

Name	The name of the port forwarding rule, the legal value length is 1-32 bytes, and it can only include numbers, letters and some special symbols (~!@#%\$^&*()_+-.)
Protocol	The network protocol corresponding to the forwarding rule, the default is TCP+UDP
External area	The default is WAN
External port	External port number, support port number (1-65535) or port range (8848-8948) configuration format
Internal area	The default is LAN
Internal IP address	IP address of the forwarded internal host
Internal port	The port number of the internal host to be forwarded, supporting the port number (1-65535) or port range (8848-8948) configuration format
Status	Whether the new port forwarding rule is enabled or not, the default is enabled

### 4.6.8 Restriction of visit

Access restriction realizes the authority management of devices in the local area network to access the external network, including three parts: IP address filtering, MAC address filtering and domain name filtering, as shown in Figure 39.

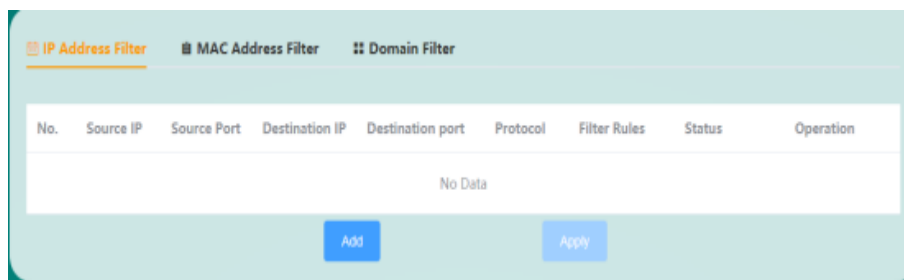

Figure 39 IP address filtering page

IP address filtering: If you want to deny the host with the IP address 192.168.30.246 to access the external network, you need to configure the source IP address as 192.168.30.246, the protocol as TCP+UDP, the filtering rule as deny, and the status as on, as shown in Figure 40.

Add IP
×

Source IP

Source Port

Destination IP

Destination port

Protocol

Filter Rules

Status Close  Open

Figure 40 Add IP page

Source IP address	To filter the IP address of the host
Source port	The default is to filter all ports of the IP host
Destination IP	The default is to restrict IP hosts from accessing all external networks
Destination port	The default is to filter IP hosts to access all ports of all external networks
Protocol	The protocol defaults to TCP+UDP, while restricting the access of the IP host's tcp and udp protocols
Filter rule	The default is deny, which restricts IP hosts from accessing the external network
Status	Whether the newly added IP filtering rule is enabled or not, it is enabled by default to be effective

MAC address filtering, as shown in Figure 41.

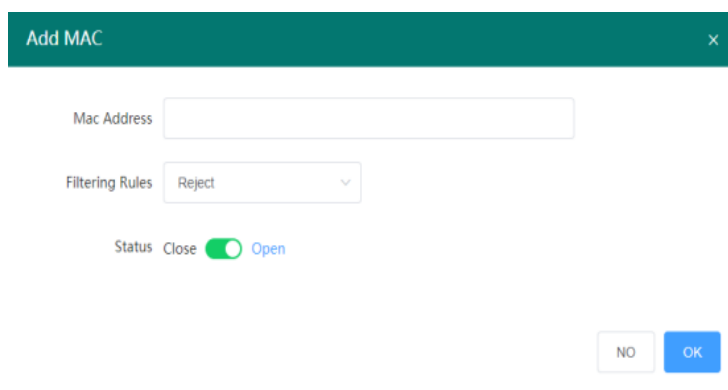

Figure 41 Add MAC page

MAC address	MAC address of the host to be filtered.
Filter rule	The default filtering rule is deny, that is, the host with the MAC address is restricted from accessing the external network through the Wi-Fi serial server.
Status	Whether the newly added MAC address filtering rule is enabled or not, it is enabled by default to be effective.

**Domain name filtering:** restrict access to the specified domain name, support the blacklist and whitelist settings of the domain name address, as shown in Figure 42.

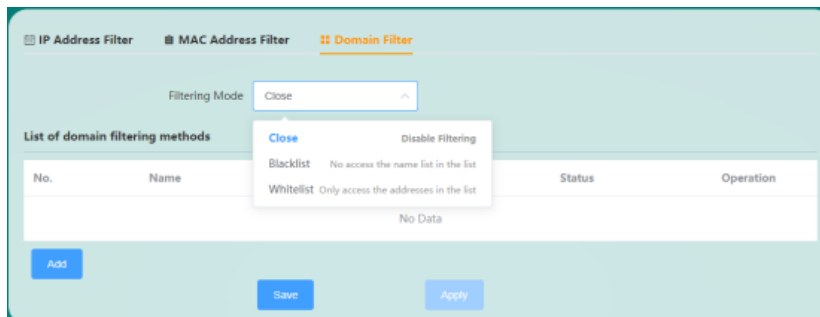

Figure 42 Domain name filtering page

The domain name filtering function is turned off by default. When the blacklist is selected, the devices connected to the WiFi serial server cannot access the domain names in the blacklist, and other domain names can be accessed normally; when the whitelist is selected, the devices connected to the Wi-Fi serial server can access except for the domain names set in the whitelist, other domain addresses cannot be accessed normally, and up to 8 domain name filtering rules can be set in the blacklist and whitelist. Add domain name setting interface as shown in Figure 43.

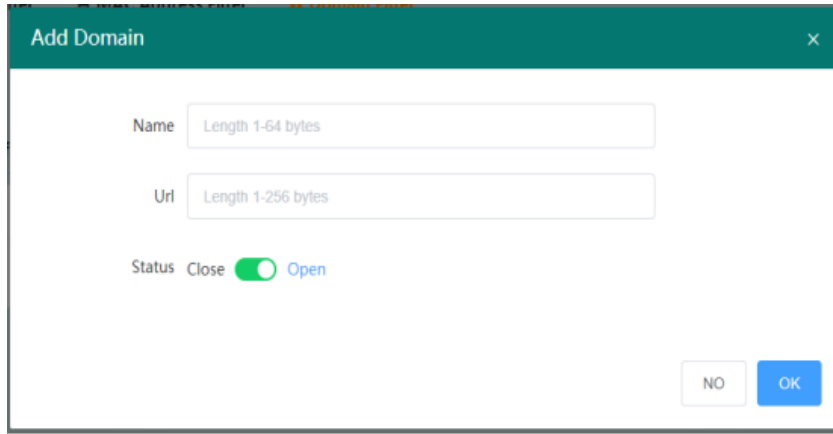

Figure 43 Add domain name page

Name	The comment name of the domain filter to be added
URL	Domain URL or domain URL keyword to add domain filter
Status	Whether the currently added domain name filtering rule is enabled or not, it is enabled by default to be effective

### 4.6.9 UPnP

Universal Plug and Play (English: Universal Plug and Play, referred to as UPnP) is a set of network protocols promoted by the "Universal Plug and Play Forum" (UPnPTM Forum). The goal of the protocol is to enable various devices in the home network (data sharing, communication and entertainment) and company networks to be seamlessly connected to each other, and to simplify the implementation of related networks. UPnP defines and publishes an open, Internet communication network protocol standard UPnP device control protocol to achieve this goal. The UPnP function is disabled by default, and the interface configuration is shown in Figure 44.

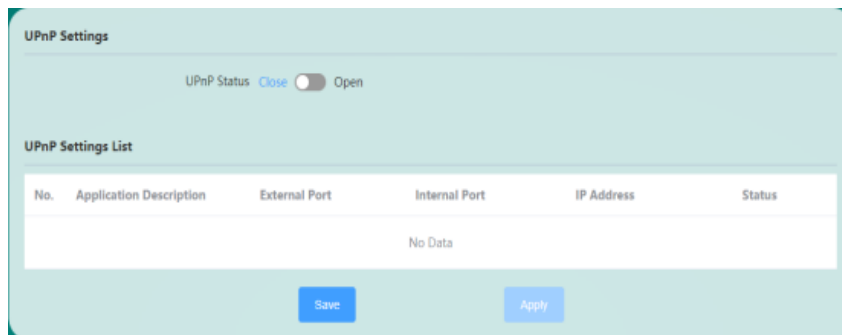

Figure 44 UPnP settings

## 4.7 System settings

System modules include: system attributes, management rights, restart, backup/upgrade, log SNMP settings, alarm settings

### 4.7.1 System properties

The current system time, host name and time zone of the Wi-Fi serial server can be displayed and set through the system property page, as shown in Figure 45.

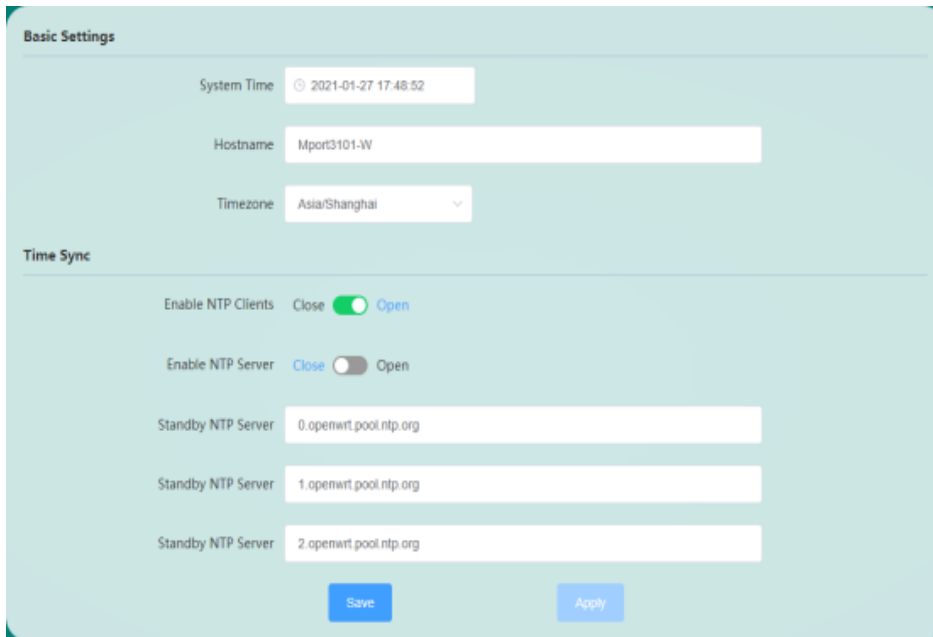

Figure 45 System Properties

System time	Get the current system time, you can modify it by clicking the clock icon, or you can synchronize the time of the browser to the time of the WiFi serial server.
Host name	The name of the current host.
Time zone	The time zone used by the current WiFi serial server.

The WiFi serial server also provides the NTP network time automatic synchronization function, and the corresponding parameters are as follows:

Enable NTP client	Enable the function of NTP Client
Enable NTP server	Enable NTP Server time synchronization service
Candidate NTP server 1~3	The WiFi serial server is configured with the NTP candidate server address by default, and the user can also modify the candidate NTP server address as needed

### 4.7.2 Management right

You can modify the administrator password on the management rights page, or add new ordinary users (up to 5 ordinary users can be added, as shown in Figure 46).

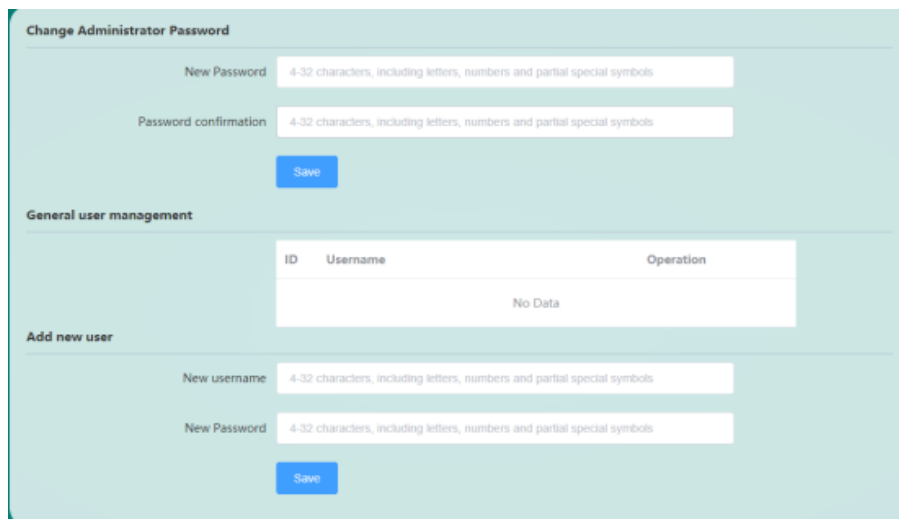

Figure 46 Management Rights Interface

The legal value length of the administrator password and the new user password is 4-32 bytes, and can only include numbers, letters and some special symbols (~!@#%&\*( ) +-).

### 4.7.3 Reboot

The user can restart the WiFi serial server immediately or set the WiFi serial server restart function on the restart page, as shown in Figure 47.

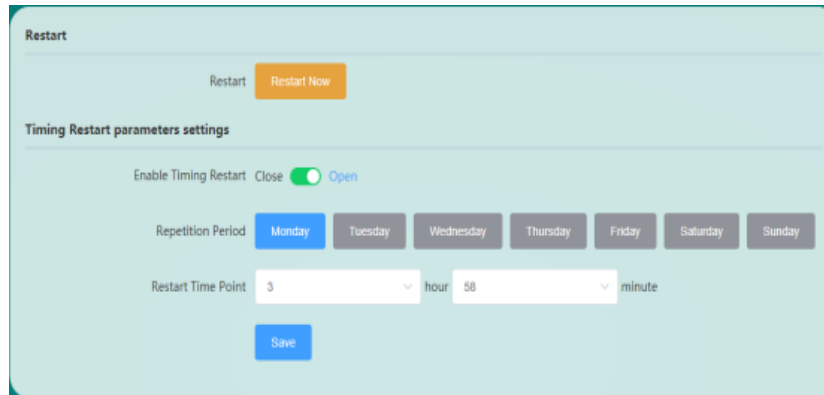

Figure 47 System restart page

The timer restart function is turned on by default (the default timer restart time is 3:58 in the morning every Monday, and the user can also turn off the timer restart function).

### 4.7.4 Backup and restore

Users can backup and restore configuration files of WiFi serial server on the "Backup and Restore" interface, restore factory settings, and flash firmware, as shown in Figure 48.

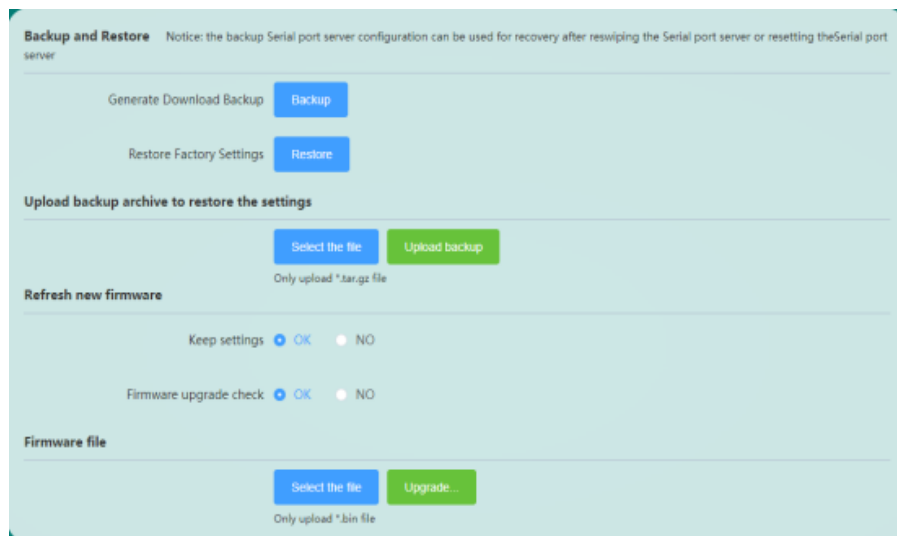

Figure 48 Backup and restore

Backup	After clicking the "Backup" button, the Wi-Fi serial server will back up the currently used parameters into a compressed file, such as backup-Mport3101-20201011172519.tar.gz, and then download and save it locally
Restore	After clicking the "Restore" button, the Wi-Fi serial server will restore the factory parameter settings and restart automatically
Upload backup	Select the configuration file, such as backup- Mport3101-W -2020011172519.tar.gz, and then click the "Upload Backup" button, the Wi-Fi serial server will save the uploaded configuration, and the configuration will take effect after automatic restart
Keep settings	When flashing the new firmware, you can choose whether to keep the current configuration of the WiFi serial server, and keep the settings by default
Firmware upgrade	Whether to turn on the check function when flashing new firmware, the check function is turned on by default
Flash firmware	Select the normal firmware file, such as Mport3101-W 1.0.238.201111.bin, and then click the "Flash Firmware" button, the Wi-Fi serial server will first check the integrity of the verification firmware, and then burn the firmware to the system and restart it automatically. The process of flashing the firmware takes about two minutes



Caution

1. Restoring the factory settings will cause all the parameters of the device to be at the factory settings, the network port defaults to the WAN mode, and the Wi-Fi defaults to the AP mode;
2. During the operation of uploading backup configuration files, do not select the configuration file of non-Wi-Fi serial server, uploading incorrect files may cause abnormal function of Wi-Fi serial server;
3. Don't cut off the power during the operation of uploading the backup configuration file, otherwise the function of the Wi-Fi serial server may be abnormal;
4. When flashing the firmware, please pay attention to the matching of the device model and version. Using a mismatched upgrade program may cause the WiFi serial server to function abnormally;
5. Power failure is not allowed during the firmware flashing process. Power failure may cause abnormal functions of the WiFi serial server. If there is an unexpected power failure during the upgrade process, please mail the product to our company immediately for possible solutions;
6. If the user configuration is confused, the Wi Fi serial server can be reset to factory settings and reconfigured.

### 4.7.5 Log

Log management function, mainly including remote log, local log and viewing and downloading three parts, as shown in Figure 49, 50, 51.

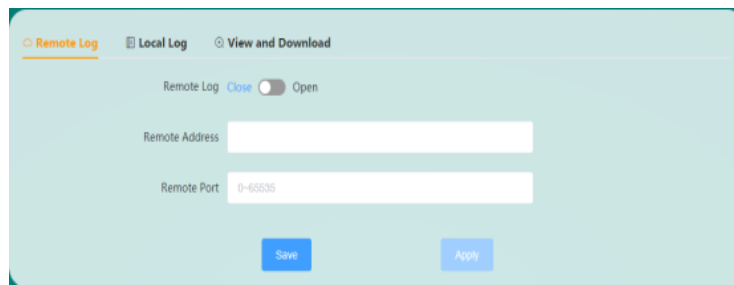

Figure 49 Remote log page

Remote log	Switch the remote log function, which is disabled by default. To enable it, you need to set the remote address and port at the same time and enable the server-side syslog service function
Remote address	IP address or domain name of the remote Log server
Remote port	Port number of the remote Log server

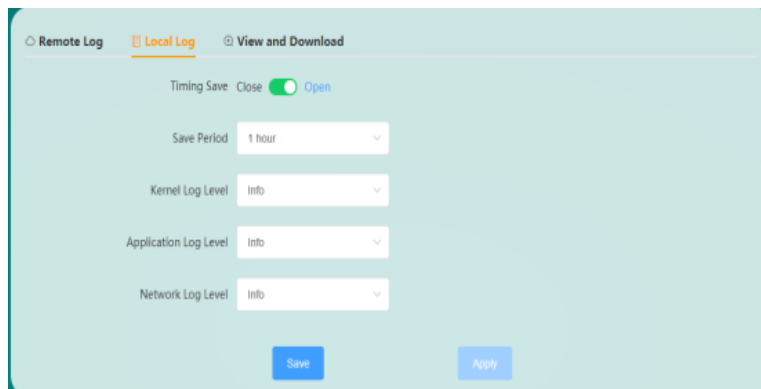

Figure 50 Local log interface

Timed save	Local log timing save switch, enabled by default
Retention period	The periodic setting of local log regular saving, the default log is saved and backed up once an hour, and it supports the function of saving the log after power-off and saving the log immediately after the system restarts.
Kernel/application /log level	System logs are divided into kernel and application logs, and log levels can be set. The log level is defined as 8 levels, followed by debugging, information, attention, warning, error, critical, warning, and emergency. The debugging level is the lowest and the emergency level is the highest; the default log level is the information level

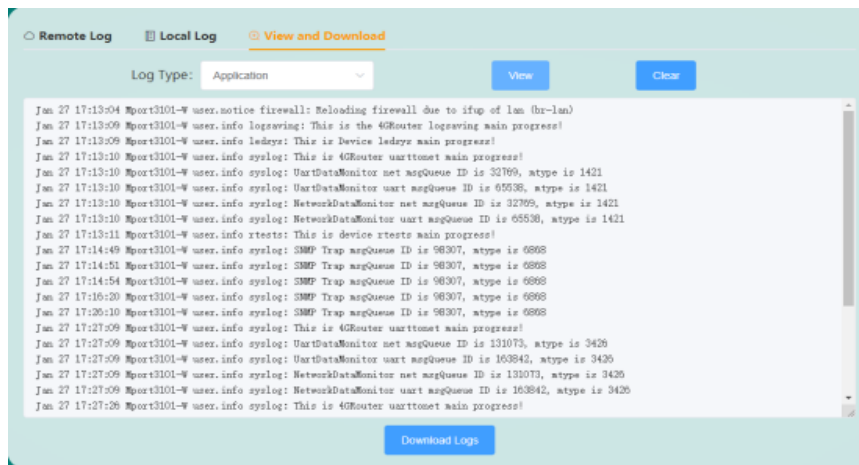

Figure 51 View and download page

View	Support log viewing by type, after selecting the log type to be viewed, click View to view the current latest log content
Download log	If you want to view all the saved history logs, click the "download log" button to download all saved history logs and the latest logs to the local for viewing

### 4.7.6 SNMP settings

SNMP (Simple Network Management Protocol, Simple Network Management Protocol) is the communication rule between the management device and the managed device in the network. It is used to manage network nodes (servers, workstations, WiFi serial servers, switches, HUBS, etc.) on the IP network. ) Is a standard protocol, which is an application layer protocol. SNMP settings support two versions, SNMP v1 and SNMP v2c, and are composed of settings, communities, and traps.

The SNMP setting page is shown in Figure 52.

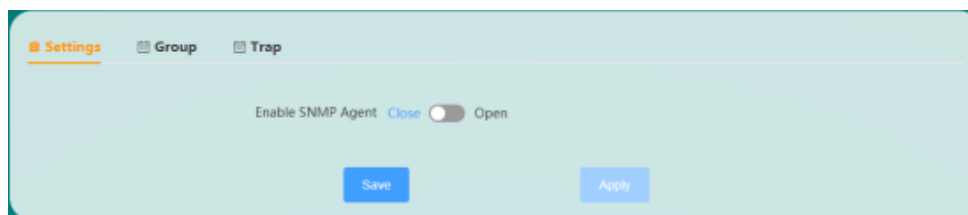

Figure 52 Settings page

Enable SNMP Agent	Enable or disable the SNMP Agent function, the SNMP Agent function is disabled by default
-------------------	---



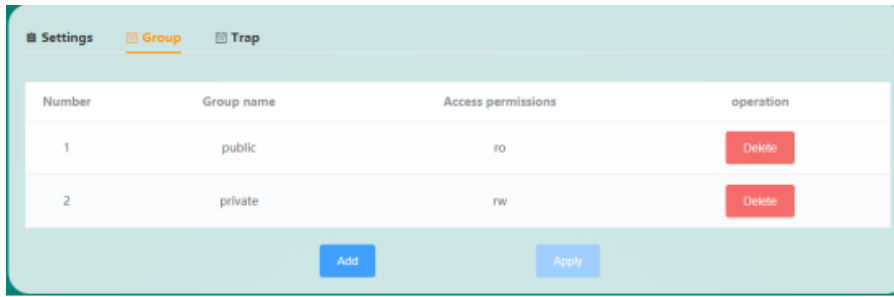

Figure 53 Group Setting Page

Group name	Set the name of the SNMP community, the length is 1-63 letters or numbers
Access permission	Set the permissions of the NMS when using the group to access the Agent. There are two types: read-only (ro) and read-write (rw)

The SNMP community setting page is shown in Figure 54.

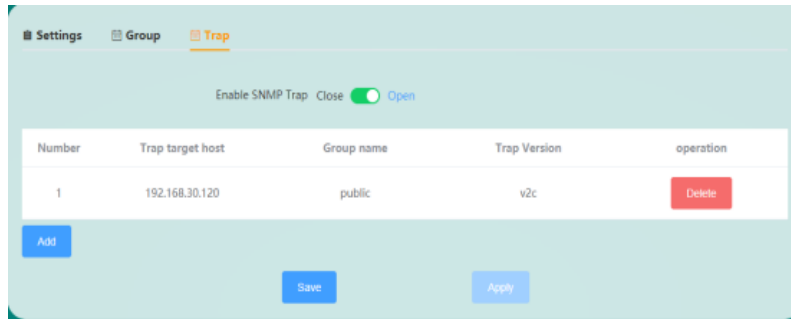

Figure 54 Trap setting page

Enable SNMP Trap	Enable or disable the SNMP TraP function. The SNMP Trap function is disabled by default. You must enable the SNMP Agent before enabling the SMP TraP function.
Trap target host	Set the IP address of the Trap target host
Group name	Set community name
Trap version	Set the version sent by SNMP Trap, which can be SNMP v1 or SNMP v2c

After the SNMP settings are completed, click Save to apply, and the serial server can be managed through NMS.

### 4.7.7 Alarm settings

This page can be used to set the mailbox for alarm events, as shown in Figure 55.

Figure 55 Alarm management page

Sender email settings	This item is used to configure the sending server, sender's mailbox, authorization code and other parameters
Recipient's email address	This item fills in the recipient's mailbox list, and the alarm event will be sent to the mailbox in the recipient's mailbox list
Alarm event settings	This item is used to configure whether to enable the device web login alarm, device parameter configuration change alarm (system property parameter), and administrator password change alarm

## Chapter 5 Maintenance and Service

From the date of product shipment, Wuhan Maiwe Communication Co., Ltd. provides a five-year product warranty. According to the product specifications of Wuhan Maiwe Communication Co., Ltd., during the warranty period, if the product has any malfunction or functional operation failure, Wuhan Maiwe Communication Co., Ltd. will repair or replace the product for the user free of charge. However, the above commitment does not cover damage caused by improper use, accidents, natural disasters, incorrect operation or incorrect installation. In order to ensure that consumers benefit from the series of products of Wuhan Maiwe Communication Co., Ltd., help and problem solving can be obtained through the following methods:

Internet service

Call the technical support office

Product repair or replacement

### 5.1 Internet service

Through the technical support section of Wuhan Maiwe Communication Co., Ltd. website, you can get more useful information and usage skills.

### 5.2 Call the technical support office

Users who use the products of Wuhan Maiwe Communication Co., Ltd. can call the technical support office of Wuhan Maiwe Communication Co., Ltd. Wuhan Maiwe Communication Co., Ltd. has professional technical engineers to answer your questions and help you in the first time Solve the product or usage problems you encountered.

### 5.3 Product repair or replacement

For product maintenance, replacement or return, in accordance with the processing procedures of Wuhan Maiwei Communication Co., Ltd., you should first contact Wuhan Maiwe Communication Co., Ltd.

The technical staff of the company will confirm, and then negotiate with the sales staff of Wuhan Maiwe Communication Co., Ltd. to complete the repair, replacement or return of the product.